

**HYDROLOGY
AND
IRRIGATION ENGINEERING
(20A01603)**

LECTURE NOTES

III - B.TECH & II-SEM

Prepared by:

C.SURESH BABU

Associate Professor

Department of Civil Engineering



SAI RAJESWARI INSTITUTE OF TECHNOLOGY
LINGAPURAM, PRODDATUR
KADAPA, Andhra Pradesh-516362



JAWAHARLAL NEHRU TECHNOLOGICAL UNIVERSITY ANANTAPUR
B.Tech (CE)– III-II Sem

L T P C
3 0 0 3

(20A01603) HYDROLOGY AND IRRIGATION ENGINEERING

Course Objectives:

- Introduce the types of irrigation systems and introduce the concepts of planning and design of irrigation systems
- Understand design methods of erodible and non-erodible canals
- Know the principles of design of hydraulic structures on permeable foundations
- Know the concepts for analysis and design principles of storage and diversion works.
- Learn design principles of canal structures

Course Outcomes:

- Design various channel systems
- Design head and cross regulator structures and also Identify various types of reservoir and their design aspects.
- By the Establishes the understanding of cross drainage works and its design.
- Students understood all type of dams and reservoirs and their designs
- Students understood Spillways, Gates & Energy dissipaters.

UNIT I

INTRODUCTION TO HYDROLOGY: Engineering hydrology and its applications; Hydrologic cycle; precipitation- Types and forms, rainfall measurement, types of rain gauges, computation of average rainfall over a basin, presentation and interpretation of rainfall data.

DESCRIPTIVE HYDROLOGY:Evaporation- Factors affecting evaporation, measurement of evaporation; Infiltration- Factors affecting infiltration, measurement of infiltration, infiltration indices; Run off- Factors affecting run- off, Computation of run-off; Design Flood; Estimation of maximum rate of run-off; separation of base flow.

UNIT II

HYDROGRAPH ANALYSIS: Hydrograph; Unit Hydrograph- Construction and limitations of Unit hydrograph, Application of the unit hydrograph to the construction of a flood hydrograph resulting from rainfall of unit duration; S-hydrograph.

GROUND WATER: Introduction; Aquifer; Aquiclude; Aquifuge; aquifer parameters- porosity, Specific yield, Specific retention; Divisions of sub-surface water; Water table; Types of aquifers; storage coefficient-coefficient of permeability and transmissibility

UNIT III

IRRIGATION: Introduction; Necessity and Importance of Irrigation; advantages and ill effects of Irrigation; types of Irrigation; methods of application of Irrigation water; quality for Irrigation water. Duty and delta; duty at various places; relation between duty and delta; factors affecting duty; methods of improving duty.

WATER REQUIREMENT OF CROPS: Types of soils, Indian agricultural soils, preparation of land for Irrigation; soil fertility; Soil-water-plant relationship; vertical distribution of soil moisture; soil moisture tension; soil moisture stress; various soil moisture constants; Limiting soil moisture conditions; Depth and frequency of irrigation; Gross command area; Culturable command area; Culturable cultivated and uncultivated area; Kor depth and Kor period; crop seasons and crop rotation; Irrigation efficiencies; Determination of irrigation requirements of crops; Assessment of Irrigation water. Consumptive use of water-factors affecting consumptive use, direct measurement and determination by use of equations (theory only)



UNIT IV

CHANNELS – SILT THEORIES: Classification; Canal alignment; Inundation canals; Cross-section of an irrigation channel; Balancing depth; Borrow pit; Spoil bank; Land width; Silt theories– Kennedy's theory, Kennedy's method of channel design; Drawbacks in Kennedy's theory; Lacey's regime theory- Lacey's theory applied to channel design; Defects in Lacey's theory; Comparison of Kennedy's and Lacey's theory.

WATER LOGGING AND CANAL LINING: Water logging; Effects of water logging; Causes of water logging; Remedial measures; Saline and alkaline soils and their reclamation; Losses in canal; Lining of irrigation channels – Necessity, advantages and disadvantages; Types of lining; Design of lined canal.

UNIT V

DIVERSION HEAD WORKS: Types of diversion head works; Diversion and Storage head works; weirs and barrages; Layouts of diversion head works; components; Causes and failure of hydraulic structures on permeable foundations; Blighs creep theory; Khoslas theory; Determination of uplift pressure, impervious floors using Blighs and Khoslas theory; Exit gradient.

Textbooks:

1. Irrigation and water power engineering by Punmia& Lal, Laxmi publications pvt. Ltd., New Delhi 17th edition 2021
2. Engineering Hydrology by K. Subramanya, The Tata Mcgraw Hill Company, Delhi 5th edition 2020

Reference Books:

1. Irrigation Engineering and Hydraulic structures by S. K. Garg; Khanna Publishers, Delhi 36th edition
2. Engineering Hydrology by Jayarami Reddy, Laxmi publications pvt. Ltd., New Delhi 3rd edition 2016
3. Irrigation and Water Resources & Water Power by P.N.Modi, Standard Book House 6th edition 2020

Online Learning Resources:

<https://nptel.ac.in/courses/105101214>

(20A01603) HYDROLOGY AND IRRIGATION ENGINEERING
UNIT-I

INTRODUCTION

The world's total water resources are estimated to be around 1.36×10^{14} ha-m. 92.7% of this water is salty and is stored in oceans and seas. Only 2.8% of total available water is fresh water. Out of this 2.8% fresh water, 2.2% is available as surface water and 0.6% as ground water. Out Of the 2.2% surface water, 2.15% is stored in glaciers and ice caps, 0.01% in lakes and streams and the rest is in circulation among the different components of the Earth's atmosphere.

Out of the 0.6% ground water only about 0.25% can be economically extracted. It can be summarized that less than 0.26% of fresh water is available for use by humans and hence water has become a very important resource. Water is never stagnant (except in deep aquifers), it moves from one component to other component of the earth through various process of precipitation, run off, infiltration, evaporation etc. For a civil engineer, it is important to know the occurrence, flow, distribution etc. it important to design and construct many structures in contact with water.

HYDROLOGY

Hydrology may be defined as applied science concerned with water of the Earth in all its states, their occurrences, distribution and circulation through the unending hydrologic cycle of precipitation, consequent runoff, stream flow, infiltration and storage, eventual evaporation and re-precipitation. Hydrology is a highly inter-disciplinary science. It draws many principles from other branches of science like:-

- Meteorology and Climatology
- Physical Geography
- Agronomy and Forestry
- Geology and Soil science
- Oceanography
- Hydraulics
- Probability and Statistics
- Ecology

Hydrology concerns itself with three forms of water:-

- Above land as atmospheric water or precipitation.
- On land or surface as stored water or runoff
- Below the land surface as ground water or percolation

(20A01603) HYDROLOGY AND IRRIGATION ENGINEERING
UNIT-I

SCOPE OF HYDROLOGY

The study of hydrology helps us to know:

1. The maximum probable flood that may occur at given sit and its frequency; this is required for the safe design of drains, bridges & culverts, dams & reservoirs, channels and other flood control system.
2. The water yield from a basin –its occurrence, quantity and frequency etc; this is necessary for the design of dams, municipal water supply, water power, river navigation etc.
3. The ground water development for which a knowledge of Hydro geology of the area i.e. formation of the soils, recharge facilities like streams and reservoirs, rainfall pattern, climate; cropping pattern etc are required.
4. The maximum intensity of storm & its frequency for the design of drainage project in the area.

IMPORTANCE OF HYDROLOGY

- Design of Hydraulic Structures: Structures such as bridges, causeways, dams, spillways etc. are in contact with water. Accurate hydrological predictions are necessary for their proper functioning. Due to a storm, the flow below a bridge has to be properly predicted. Improper prediction may cause failure of the structure. Similarly the spillway in case of a dam which is meant for disposing excess water in a dam should also be designed properly otherwise flooding water may overtop the dam.
- Municipal and Industrial Water supply: Growth of towns and cities and also industries around them is often dependent on fresh water availability in their vicinity. Water should be drawn from rivers, streams, ground water. Proper estimation of water resources in a place will help planning and implementation of facilities for municipal (domestic) and industrial water supply.
- Irrigation: Dams are constructed to store water for multiple uses. For estimating maximum storage capacity seepage, evaporation and other losses should be properly estimated. These can be done with proper understanding of hydrology of a given river basin and thus making the irrigation project a successful one. Artificial recharge will also increase ground water storage. It has been estimated that ground water potential of gangetic basin is 40 times more than its surface flow.

(20A01603) HYDROLOGY AND IRRIGATION ENGINEERING
UNIT-I

- Hydroelectric Power Generation: A hydroelectric power plant need continuous water supply without much variations in the stream flow. Variations will affect the functioning of turbines in the electric plant. Hence proper estimation of river flow and also flood occurrences will help to construct efficient balancing reservoirs and these will supply water to turbines at a constant rate.
- Flood control in rivers: Controlling floods in a river is a complicated task. The flow occurring due to a storm can be predicted if the catchment characteristics are properly known. In many cases damages due to floods are high. Joint work of hydrologist and meteorologists in threatening areas may reduce damage due to floods. Flood plain zones maybe demarked to avoid losses.
- Navigation: Big canals in an irrigation scheme can be used for inland navigation. The depth of water should be maintained at a constant level. This can be achieved by lock gates provided and proper draft to be maintained. If the river water contains sediments, they will settle in the channel and cause problems for navigation. Hence the catchment characteristics should be considered and sediment entry into the canals should be done.
- Erosion & sediment control: Excessive erosion in the catchment feeds the sediment into the runoff. The reservoir may lose their capacity at a faster rate reducing their economic span drastically. Tones of fertile top soil will be lost every year resulting in crop yields. Hydrology of the catchment along with the knowledge of the existing water shed management practices will help in finding out the effective erosion. These measures include the fixing crop pattern & cropping procedures, formation of contour bunds, afforestation etc. effective erosion control measures not only decreases the sediment load in the stream but also reduces peak flood discharges because of increased infiltration opportunities in the catchment.
- Pollution control: It is an easy way to dispose sewage generated in a city or town into streams and rivers. If large stream flow is available compared to the sewage discharge, pollution problems do not arise as sewage gets diluted and flowing water also has self-purifying capacity. The problem arises when each of the flows are not properly estimated. In case sewage flow is high it should be treated before disposal into a river or stream.

(20A01603) HYDROLOGY AND IRRIGATION ENGINEERING
UNIT-I

HYDROLOGICAL CYCLE

Water exists on the earth in gaseous form (water vapor), liquid and solid (ice) forms and is circulated among the different components of the Earth mainly by solar energy and planetary forces. Sunlight evaporates sea water and this evaporated form is kept in circulation by gravitational forces of Earth and wind action. The different paths through which water in nature circulates and is transformed is called hydrological cycle. Hydrological cycle is defined as the circulation of water from the sea to the land through the atmosphere back to the sea often with delays through process like precipitation, interception, runoff, infiltration, percolation, ground water storage, evaporation and transpiration also water that returns to the atmosphere without reaching the sea.

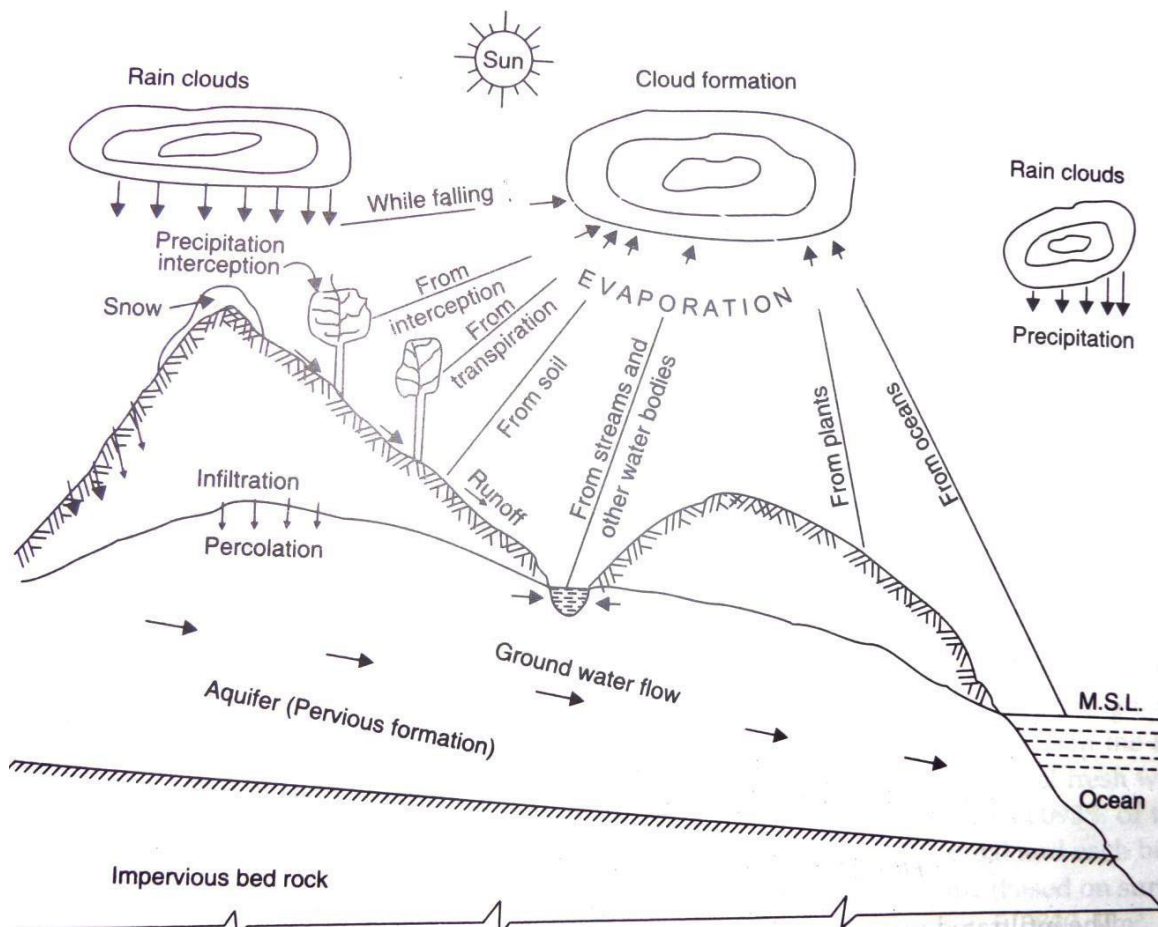

FIG : Descriptive representation of hydrological cycle

The hydrological cycle has 3 important phases:

1. Evaporation & Evapotranspiration
2. Precipitation
3. Run off

Evaporation takes place from the surface of ponds, lakes, reservoirs, and ocean surfaces.

Transpiration takes place from surface vegetation i.e. from plant leaves of cropped land forest

(20A01603) HYDROLOGY AND IRRIGATION ENGINEERING
UNIT-I

etc. These vapours rise to sky and are condensed at higher altitude and form the clouds. The clouds melt and sometime burst resulting in precipitation of different forms like rain, snow, hail, mist and frosts. A part of this precipitation flows over the land as runoff and a part infiltrate into the soil which build up ground water table. The surface run-off joins the stream and thus water stored in the reservoir. A portion of the surface runoff and ground water flows back to ocean. Again, evaporation starts from surfaces of lakes, reservoirs and ocean & thus the cycle repeats.

The hydrological cycle can also be represented in many different ways in diagrammatic forms as

1. Horton's Qualitative representation
2. Horton's Engineering representation

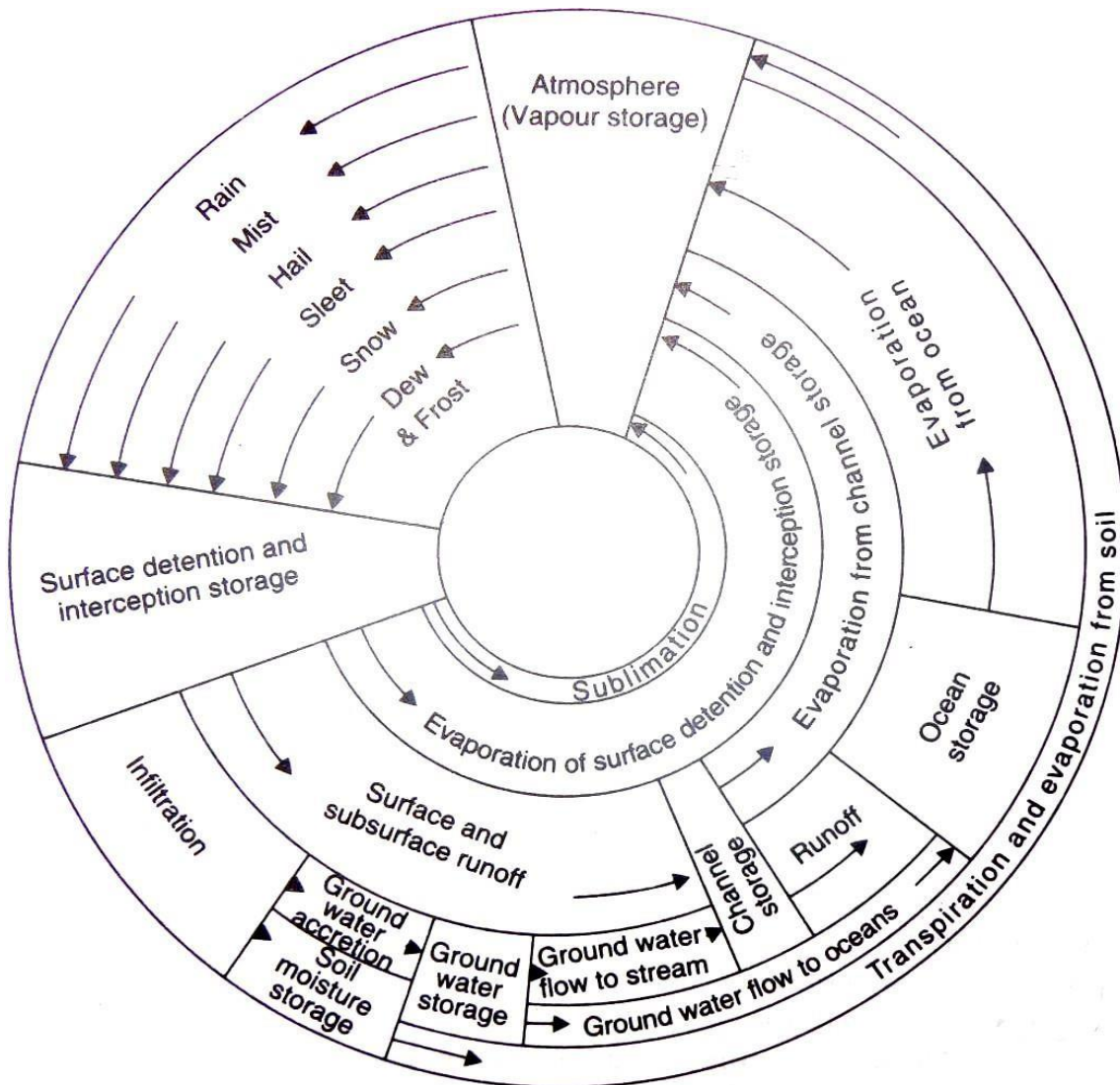

FIG : Qualitative representation of Horton's hydrological Cycle

(20A01603) HYDROLOGY AND IRRIGATION ENGINEERING
UNIT-I

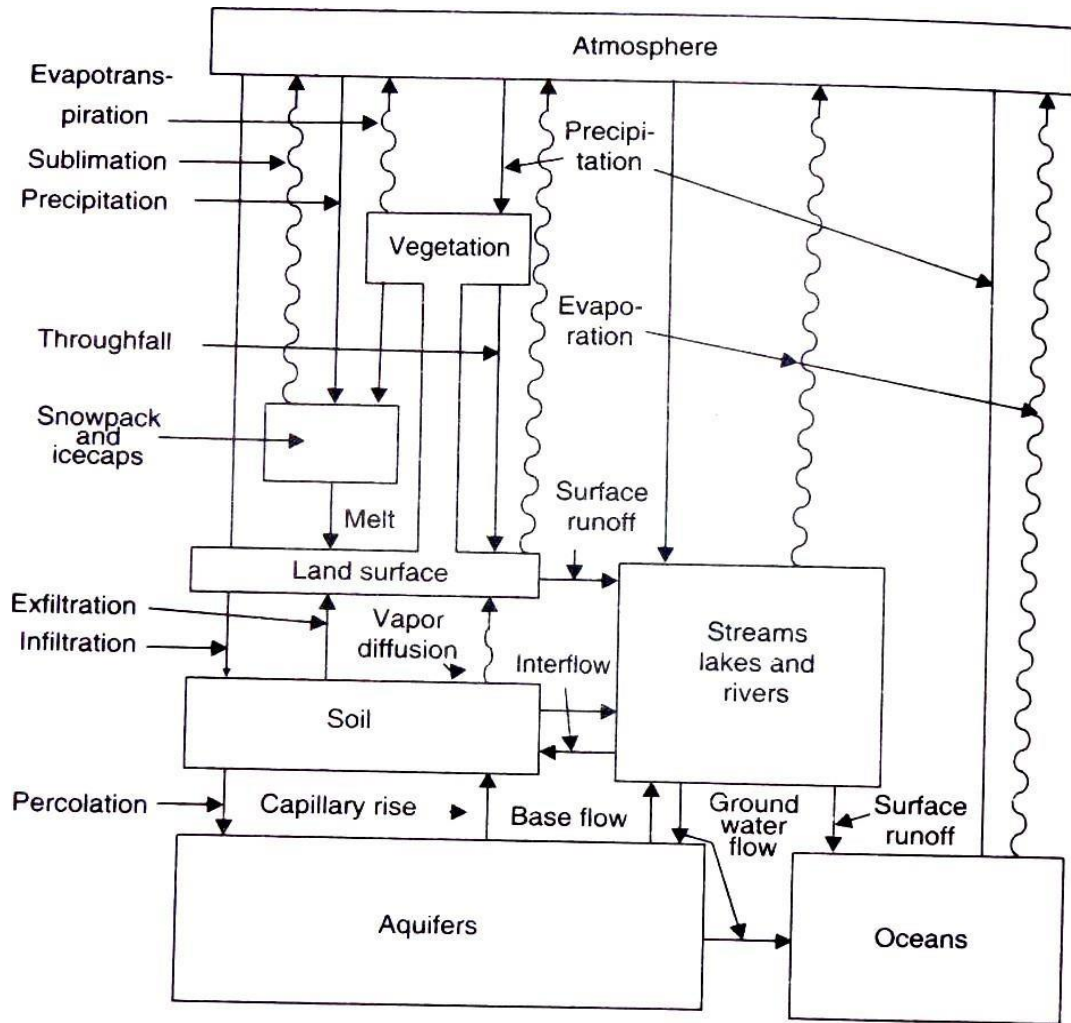
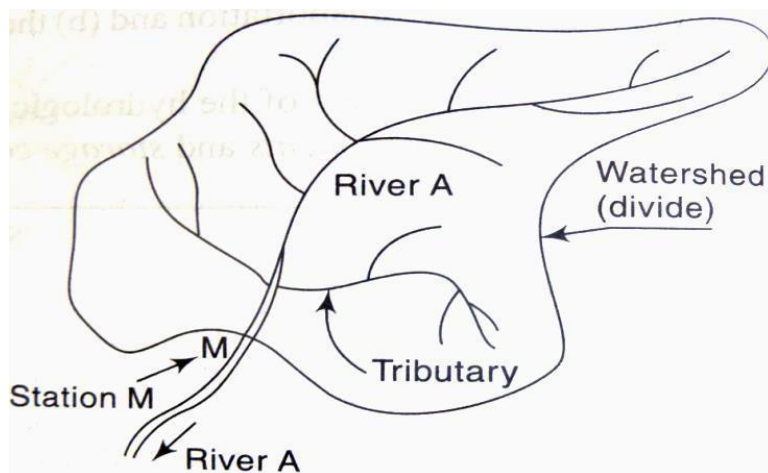

FIG : Engineering representation of Horton's hydrological Cycle

WATER BUDGET EQUATION FOR A CATCHMENT

The area of land draining into a stream at a given location is known as catchment area or drainage area or drainage basin or water shed.



(20A01603) HYDROLOGY AND IRRIGATION ENGINEERING
UNIT-I

For a given catchment area in any interval of time, the continuity equation for water balance is given as: (Change in mass storage) = (mass in flow) - (mass outflow)

$$\Delta s = V_i - V_o$$

The water budget equation for a catchment considering all process for a time interval Δt is written as: $\Delta s = P - R - G - E - T$

Where, Δs represent change in storage

P- Precipitation, G- Net ground water flowing outside the catchment, R- Surface runoff

E- Evaporation, T- Transpiration

Storage of water in a catchment occurs in 3 different forms and it can be written as:

$$S = S_s + S_m + S_g$$

Where, S- storage, S_s - Surface water storage, S_m - soil moisture storage,

S_g - ground water storage

Hence change in storage maybe expressed as:

$$\Delta S = \Delta S_s + \Delta S_m + \Delta S_g$$

The rainfall runoff relationship can be written as: $R = P - L$

R- Surface runoff, P- Precipitation, L- Losses

i.e. water not available to runoff due to infiltration, evaporation, transpiration and surface storage.

PRECIPITATION

It is defined as the return of atmospheric moisture to the ground in the form of solids or liquids. Precipitation is the fall of water in various forms on the earth from the cloud. The usual form of precipitation is rain and snow. In India snowfall occurs only in Himalayan region during winter. Most of the precipitation occur in India is the form of rain.

The following are the main characteristics of rainfall:

a. Amount or quantity: The amount of rainfall is usually given as a depth over a specified area, if all the rainfall accumulates over the surface and the unit for measuring amount of rainfall is cm. The volume of rainfall = Area x Depth of Rainfall (m^3)

The amount of rainfall occurring is measured with the help of rain gauges.

b. Intensity: This is usually average of rainfall rate of rainfall during the special periods of a storm and is usually expressed as cm/ hour.

c. Duration of Storm: In the case of a complex storm, we can divide it into a series of storms of different durations, during which the intensity is more or less uniform.

(20A01603) HYDROLOGY AND IRRIGATION ENGINEERING
UNIT-I

d. **Aerial distribution:** During a storm, the rainfall intensity or depth etc. will not be uniform over the entire area. Hence, we must consider the variation over the area i.e. the aerial distribution of rainfall over which rainfall is uniform.

DEFINITIONS

Infiltration: Infiltration is the passage of water across the soil surface. The vertical downward movement of water within the soil is known as percolation. The infiltration capacity is the maximum rate of infiltration for the given condition of the soil. Obviously the infiltration capacity decreases with time during/ after a storm.

Overland Flow: This is the part of precipitation which is flowing over the ground surface and is yet to reach a well-defined stream.

Surface runoff: When the overland flow enters a well-defined stream it is known as surface runoff (SRO).

Interflow for Sub surface flow: A part of the precipitation which has in-filtered the ground surface may flow within the soil but close to the surface. This is known as interflow. When the interflow enters a well-defined stream, then and only it is called run off.

Ground water flow: This is the flow of water in the soil occurring below the ground water table. The ground water table is at the top level of the saturated zone within the soil and it is at atmospheric pressure. Hence it is also called phreatic surface. A portion of water may enter a well-defined stream. Only then it is known as runoff or base flow. Hence, we say that runoff is the portion of precipitation which enters a well-defined stream and has three components; namely- surface runoff, interflow runoff and ground water runoff or base flow.

Evaporation: This is the process by which state of substance (water) is changed from liquid state to vapor form. Evaporation occurs constantly from water bodies, soil surface and even from vegetation. In short evaporation occurs when water is exposed to atmosphere (during sunlight). The rate of evaporation depends on the temperature and humidity.

Transpiration: This is the process by which the water extracted by the roots of the plants is lost to the atmosphere through the surface of leaves and branches by evaporation. Hence it is also known as evapotranspiration.

(20A01603) HYDROLOGY AND IRRIGATION ENGINEERING
UNIT-I

FORMS OF PRECIPITATION

1. Drizzle – This is a form of precipitation consisting of water droplets of diameter less than 0.05 cm with intensity less than 0.01cm/ hour. In this drop are so small that they appear to flow in the air.
2. Rainfall – This is a form of precipitation of water drops larger than 0.05cm diameter up to 0.6cm diameter. Water drops of size greater than 0.6 cm diameter tend to break up as they fall through the atmosphere. Intensity varies from 0.25 cm/ hour to 0.75cm/ hour.
Light Rain – Traced to 0.25cm/hr
Moderate rain – 0.25cm/hr to 0.75cm/hr
Heavy rain – greater than 0.75cm/hr
3. Snow – This is precipitation in the form of ice crystals. These crystals usually carry a thin coating of liquid water and form large flakes when they collide with each other.
4. Hail – The precipitation in the form of balls are irregular of ice of diameter 5mm or more is called Hail.
5. Glaze (Freezing Rain) – This is the ice coating formed when a drizzle or rainfall comes in contact with very old objects on the ground. It occurs when there is cold layer of air with temperature below 0⁰C
6. Sleet – Sleet is the precipitation in the form of melting snow. It is a mixture of snow and rain. It is in the form of pellet of diameter 1mm-4mm. Sleet is also known as small hail.
7. Frost – Frost is a form of precipitation which occurs in the form of scales, needles, feathers or fans.
8. Dew – Dew is a form of precipitation which doesn't occur because of condensation in higher layer of atmosphere but it is formed by condensation directly on the ground. Dew occurs in the night when the ground surface is cooled by outgoing radiation.

FORMATION OF PRECIPITATION

Precipitation occurs when the following four conditions are satisfied:

- Cooling of air masses
- Formation of clouds into ice crystals due to condensation
- Growth of water droplets
- Accumulation of moisture

(20A01603) HYDROLOGY AND IRRIGATION ENGINEERING
UNIT-I

Cooling of air masses

Cooling occurs when air ascends from earth surface to upper level in the atmosphere. The decrease in temperature of undisturbed atmospheric air with an increase in altitude is called lapse rate ($6.5^{\circ}\text{C}/\text{km}$). The precipitation depends on the lapse rate and amount of cooling.

Formation of clouds due to condensation

Condensation occurs when the water vapour in the atmosphere is converted into liquid droplet or into ice crystals when temperature is quite low. Clouds are formed due to condensation. The water vapour converted into water droplets due to the presence of small solid particles called condensation nuclei or Hygroscopic nuclei of sizes 0.001 micron to 10 micron. The rate of condensation increases as the number of nuclei increases.

Growth of water droplets

The size of water droplets in a cloud is usually very small of about 0.02mm. However this cannot reach the ground unless there is growth in water droplet. This can be achieved by means of coalescence. Coalescence of droplets occurs to form larger drops and is due to difference of velocity of larger droplets and smaller droplets and due to co-existence of ice crystals and water droplets in clouds.

Accumulation of moisture

The air must contain sufficient amount of moisture so that appreciable precipitation can occur after meeting the evaporation losses between the clouds and ground. Accumulation of moisture in atmosphere occurs due to evaporation of lands, vegetation and water surfaces.

TYPES OF PRECIPITATION

One of the essential requirements for precipitation to occur is the cooling of large masses of moist air. Lifting of air masses to higher altitudes is the only large scale process of cooling. Hence the types of precipitation based on the mechanism which causes lifting of air masses are as follows:

1. Convective precipitation: This is due to the lifting of warm air which is lighter than the surroundings. Generally this type of precipitation occurs in the tropics where on a hot day, the ground surface gets heated unequally causing the warmer air to lift up and precipitation occurs in the form of high intensity and short duration. This usually occurs in the form of a local whirling thunder storm and for very short duration, it is called

(20A01603) HYDROLOGY AND IRRIGATION ENGINEERING
UNIT-I

'tornado', when accompanied by very high velocity destructive winds. Convective precipitation covers small area and rainfall intensity may be very high (10cm/hr).

2. Orographic Precipitation: It is the most important precipitation and is responsible for most of heavy rains in India. Orographic precipitation is caused by air masses which strike some natural topographic barriers like mountains and cannot move forward and hence the rising amount of precipitation. The greatest amount of precipitation falls on the windward side and leeward side has very little precipitation.

Ex: Cherrapunji, Agumbe in Western Ghats of southern India gets heavy Orographic precipitation.

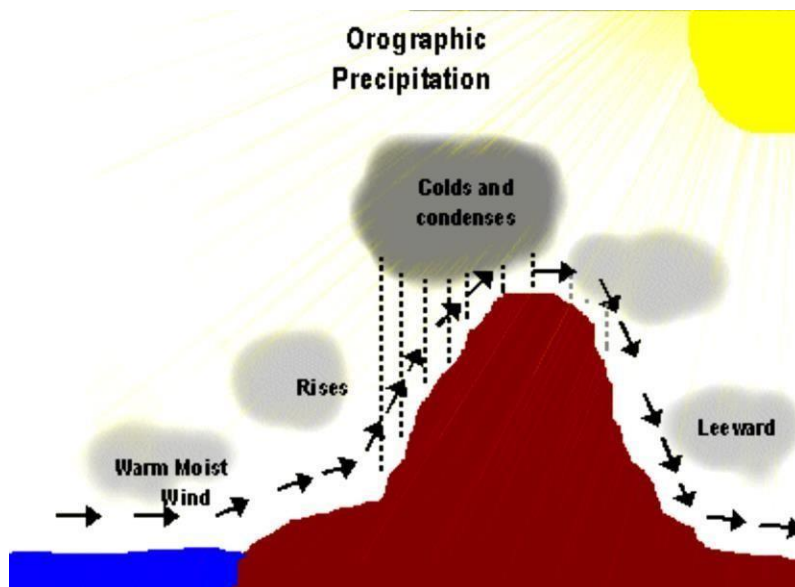

3. Cyclonic Precipitation: This is the precipitation associated with cyclones or moving masses of air and involves the presence of low pressures. A cyclone is a large zone of low pressure which is surrounded by a circular wind motion. This type of precipitation occurs due to pressure differences created by the unequal heating of earth's surface. Air tends to move into low pressure zone from surrounding areas and displaces low pressure air upwards. The wind blows spirally inward counter clockwise in the northern hemisphere and clockwise in the southern hemisphere.

This is further sub divided into 2 categories

- a. Non Frontal cyclonic precipitation: In this, a low pressure area develops. (Low-pressure area is a region where the atmospheric pressure is lower than that of surrounding locations). The air from surroundings converges laterally towards the low pressure area. This results in lifting of air and hence cooling. It may result in precipitation.

(20A01603) HYDROLOGY AND IRRIGATION ENGINEERING
UNIT-I

- b. Frontal cyclonic precipitation: FRONT is a barrier region between two air masses having different temperature, densities, moisture, content etc. If a warm and moist air mass moves upwards over a mass of cold and heavier air mass, the warm air gets lifted, cooled and may result in precipitation. Such a precipitation is known as warm front precipitation.

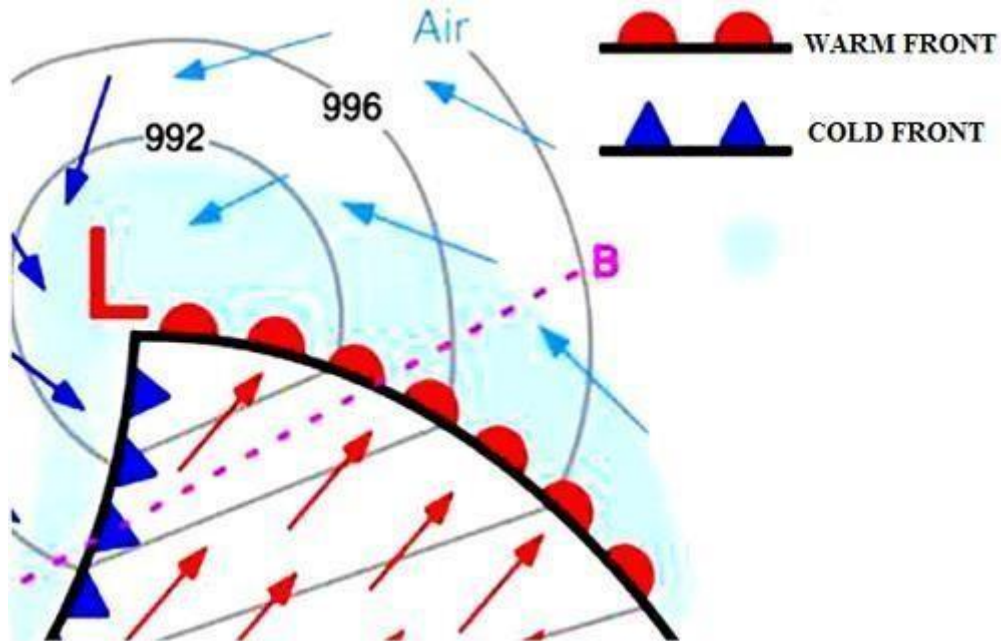

FIG: Cyclonic precipitation

4. Turbulent Precipitation: This precipitation is usually due to a combination of the several of the above cooling mechanisms. The change in frictional resistance as warm and moist air moves from the ocean onto the land surface may cause lifting of air masses and hence precipitation due to cooling. This precipitation results in heavy rainfall. The winter rainfall in Tamilnadu is mainly due to this type of turbulent ascent.

MEASUREMENT OF RAINFALL

Rainfall is measured on the basis of the vertical depth of water accumulated on a level surface during an interval of time, if all the rainfall remained where it fell. It is measured in mm'. The instrument used for measurement of rainfall is called "Rain gauge". These are classified as:

- Non recording type Raingauge
- Recording type Raingauge

Non recording type Raingauges

These rain gauges which do not record the depth of rainfall, but only collect rainfall. Symon's rain gauge is the usual non recording type of rain gauge. It gives the total rainfall that has

(20A01603) HYDROLOGY AND IRRIGATION ENGINEERING
UNIT-I

occurred at a particular period. It essentially consists of a circular collecting area 127 mm in diameter connected to a funnel. The funnel discharges the rainfall into a receiving vessel. The funnel and the receiving vessel are housed in a metallic container. The components of this rain gauge are as shown in fig below.

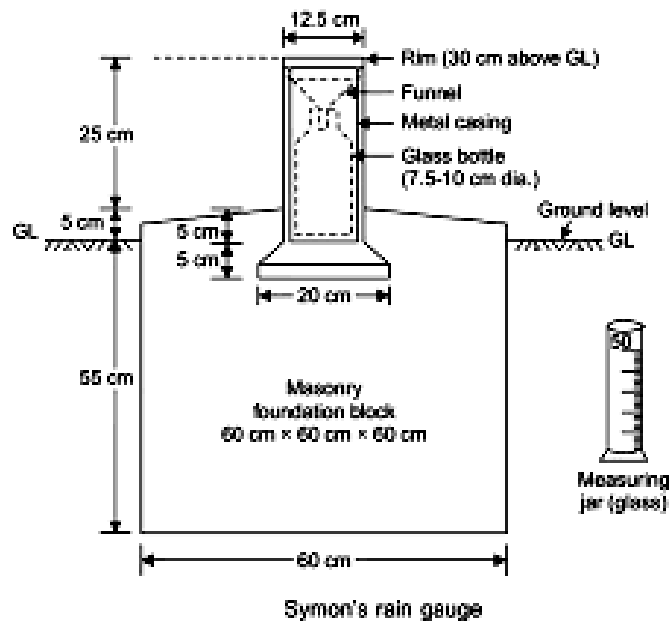

FIG : Symons rain gauge

The water collected in the receiving bottle is measured by a graduated measuring jar with an accuracy of 0.1 ml. the rainfall is measured every day at 8:30 am IST and hence this rain gauge gives only depth of rainfall for previous 24 hours. During heavy rains, measurement is done 3 to 4 times a day.

Thus, Symons Rain gauge gives only the total depth of rainfall for previous 24 hours and does not provide intensity and rainfall duration of the rainfall during different time interval of the day.

1.1.1 Recording type Rain gauges

These are rain gauges which can give a permanent, automatic rainfall record (without any bottle recording) in the form of a pen mounted on a clock driven chart. From the chart intensity or rate of rainfall in cm per hour or 6 hrs., 12 hrs..... besides the total amount of rainfall can be obtained.

Advantages of recording rain gauges:

1. Necessity of an attendant does not arise
2. Intensity of rainfall at any time as well as total rainfall is obtained, whereas non recording gauge gives only total rainfall.

(20A01603) HYDROLOGY AND IRRIGATION ENGINEERING
UNIT-I

3. Data from in accessible places (hilly regions) can be continuously obtained.
4. Human errors are eliminated.
5. Capacity of gauges is large.
6. Time intervals are also recorded.

Disadvantages of recording rain gauges:

1. High initial investment cost.
2. Recording is not reliable when faults in gauge arise (mechanical or electrical) till faults are corrected.

TYPES OF RECORDING RAINGAUGE

Tipping bucket rain gauge:

This is the most common type of automatic rain gauge adopted by U S Meteorological Department.

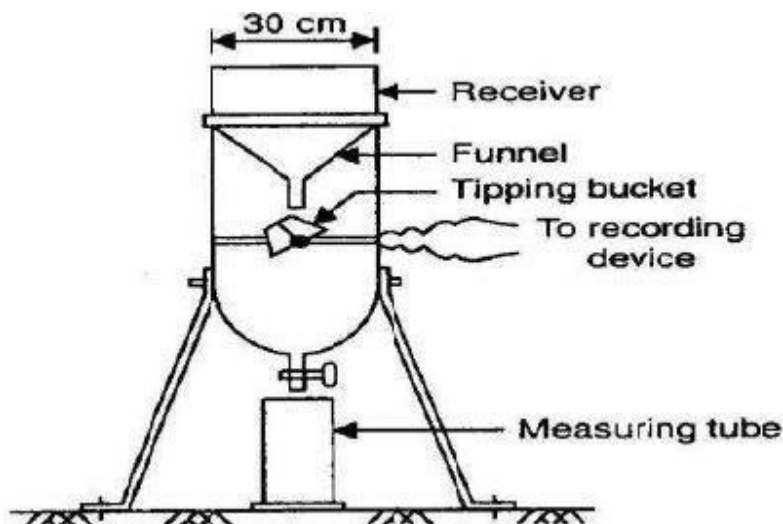

FIG: Tipping Bucket Rain gauge

This consists of receiver draining into a funnel of 30 cm diameter. The catch (rainfall) from funnel falls into one of the pair of small buckets (tipping buckets). These buckets are so balanced that when 0.25 mm of rainfall collects in one bucket, it tips and brings the other bucket into position.

Tipping of bucket completes an electric circuit causing the movement of pen to mark on clock driven receiving drum which carries a recorded sheet. These electric pulses generated are recorded at the control room far away from the rain gauge station. This instrument is further suited for digitalizing the output signal.

(20A01603) HYDROLOGY AND IRRIGATION ENGINEERING
UNIT-I

The tipping bucket Rain gauge is quiet durable, simple to operate and convenient but it has following disadvantage:

- It does not give accurate result in case of intense rainfall, because some of rain which falls during the tipping of bucket is not measured.
- Because of discontinuous nature of the record, the instrument is not satisfactory for using light drizzle or very light rain.
- The time of beginning and ending of rainfall cannot be determined accurately.
- This gauge is not suitable for measuring snow without heating the collector.

Weighing bucket rain gauge:

This is the most common type of recording or automatic rain gauge adopted by Indian Meteorological Department. The construction of this rain gauge is shown in figure below.

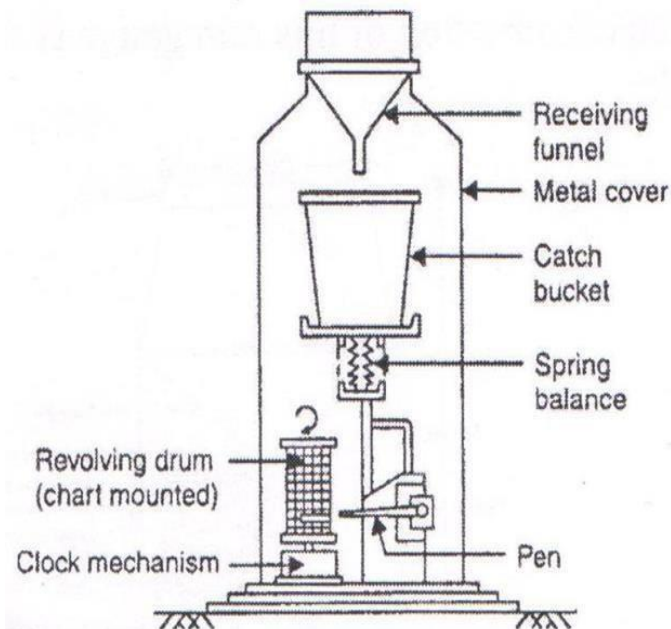
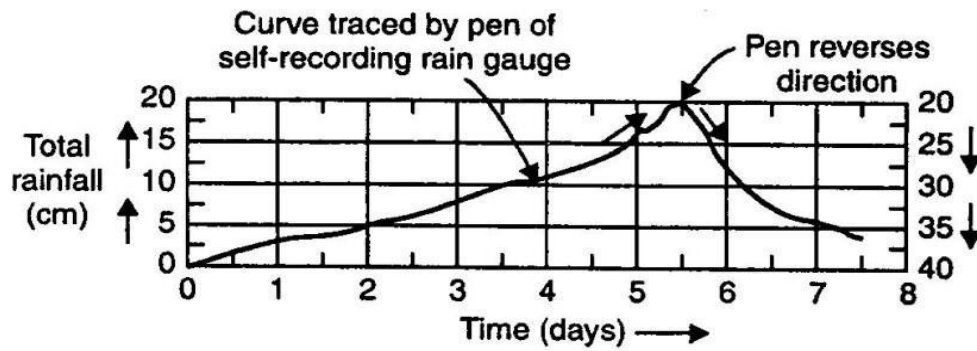

FIG: Weighing Bucket Rain gauge

It consists of a receiving bucket supported by a spring or lever. The receiving bucket is pushed down due to the increase in weight (due to accumulating rain fall). The pen attached to the arm continuously records the weight on a clock driven chart. The chart obtained from this rain gauge is a mass curve of rain fall.

UNIT-I



Mass curve of rainfall

From the mass curve the average intensity of rainfall (cm/hr) can be obtained by calculating the slope of the curve at any instant of time. The patterns as well as total depth of rain fall at different instants can also be obtained.

The advantages of this Rain gauge are that it can record snow, hail and mixture of rain and snow.

The disadvantages are:

- The effect of temperature and friction on weighing mechanism may introduce error.
- Failure of reverse mechanism results in loss of record.
- Because of wind action on bucket, erratic traces may be recorded on the chart.

Siphon or float type rain gauge

This is also called integrating rain gauge as it depicts an integrated graph of rain fall with respect to time. The construction of this rain gauge is shown in figure below.

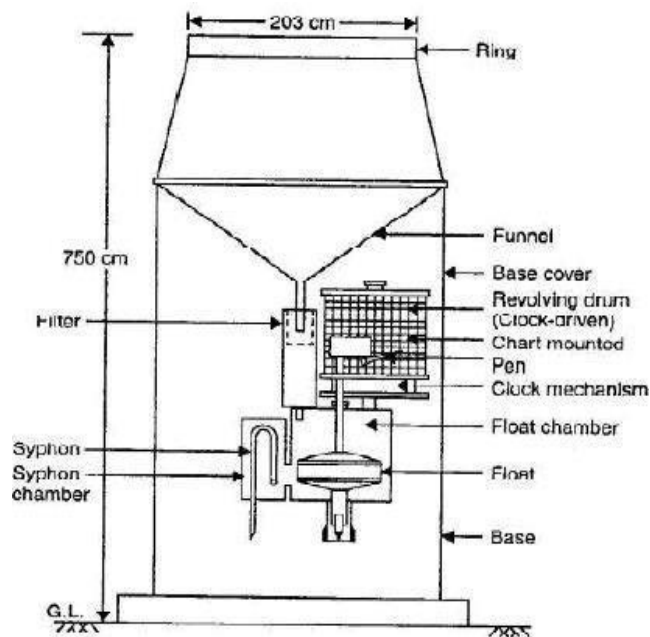

FIG: SIPHON RAINGAUGE

(20A01603) HYDROLOGY AND IRRIGATION ENGINEERING
UNIT-I

A receiver and funnel arrangement drain the rainfall into a container, in which a float mechanism at the bottom is provided. As water accumulates, the float rises. A pen arm attached to the float mechanism continuously records the rainfall on a clock driven chart and also produces a mass curve of rain fall. When the water level rises above the crest of the siphon, the accumulated water in the container will be drained off by siphonic action. The rain gauge is ready to receive the new rainfall.

Radar measurement of rainfall

The principle involves RADAR as shown in figure below. Electromagnetic waves known as pulses are produced by a transmitter and are radiated by a narrow beam antenna. The reflections of these waves from the targets (echoes) are again intercepted by the same antenna. A receiver detects these echoes, amplifies and transforms them into video form on an indicator called Plan Position indicator. The screen of indicator is illuminated dimly where there is no target (rainfall) and a bright spot occurs where there is a target and a bright patch where there is an extended object such as rain shower.

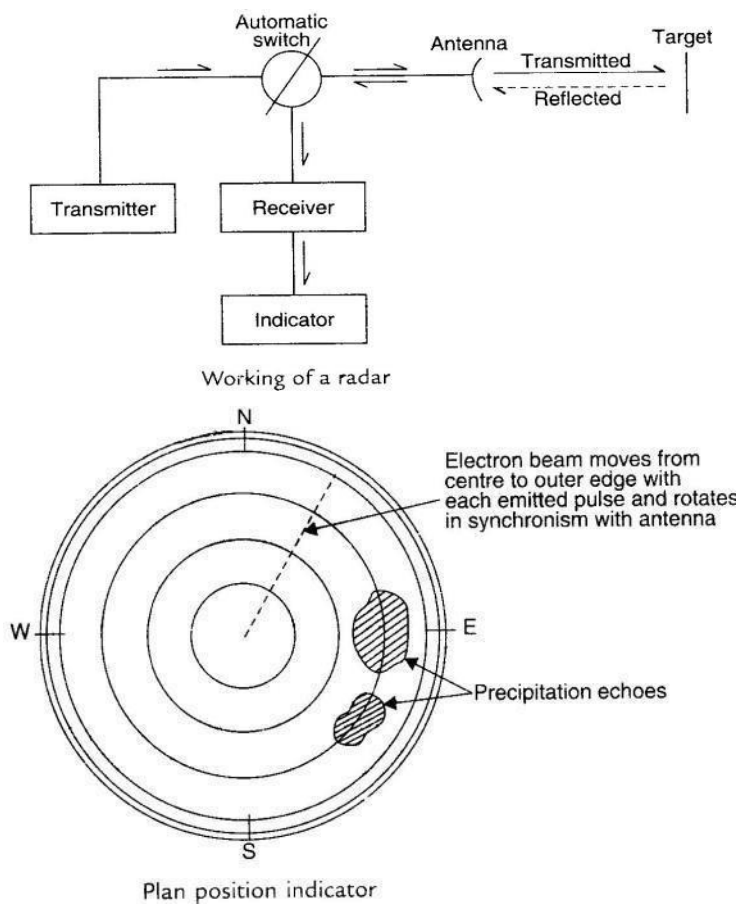

(20A01603) HYDROLOGY AND IRRIGATION ENGINEERING
UNIT-I

FACTORS GOVERNING SELECTION OF SITE FOR RAIN GAUGE STATIONS:

- The site for rain gauge station should be an open space without the presence of trees or any covering.
- The rain gauge should be properly secured by fencing.
- The site for rain gauge station should be a true representation of the area which is supposed to give rainfall data.
- The distance of any object or fence from the rain gauge should not be less than twice the height of the object or fence and in no case less than 30 m.
- The rain gauge should not be set upon the peak or sides of a hill, but on a nearby level ground.
- The rain gauge should be protected from high winds.
- The rain gauge should be always easily accessible to the observers.

DETERMINATION OF AVERAGE PRECIPITATION OVER AN AREA

The rainfall measured by a rain gauge is called point precipitation because it represents the rainfall pattern over a small area surrounding the rain gauge station. However, in nature rain fall pattern varies widely. The average precipitation over an area can be obtained only if several rain gauges are evenly distributed over the area. But there is always limitation to establish several rain gauges. However, this draw back can be overcome by adopting certain methods as mentioned below, which give fair results.

Arithmetic mean method: In this method to determine the average precipitation over an area the rainfall data of all available stations are added and divided by the number of stations to give an arithmetic mean for the area. That is if P_1 , P_2 and P_3 are the precipitations recorded at three stations A, B and C respectively, then average precipitation over the area covered by the rain gauges is given by

$$P_{av} = \frac{P_1 + P_2 + P_3}{3}$$

This method can be used if the area is reasonably flat and individual gauge readings do not deviate from the mean (average). This method does not consider aerial variation of rainfall, non-even distribution of gauges, Orographic influences (presence of hills), etc. This method can also be used to determine the missing rain fall reading from any station also in the given area.

(20A01603) HYDROLOGY AND IRRIGATION ENGINEERING
UNIT-I

Thiessen Polygon method: This is also known as weighted mean method. This method is very accurate for catchments having areas from 500 to 5000 km². In this method rainfall recorded at each station is given a weight age on the basis of the area enclosing the area. The procedure adopted is as follows.

The rain gauge station positions are marked on the catchment plan.

- Each of these station positions are joined by straight lines.
- Perpendicular bisectors to the previous lines are drawn and extended up to the boundary of the catchment to form a polygon around each station.
- Using a planimeter, the area enclosed by each polygon is measured.
- The average precipitation over an area is given as

$$(P_{av} = P_1A_1+P_2A_2+P_3A_3+\dots\dots\dots +P_nA_n / A_1+A_2+A_3+\dots\dots\dots +A_n)$$

Where P₁, P₂, P₃..... P_n are rainfall amounts obtained from 1 to n rain gauge stations respectively are areas of polygons surrounding each station.

A₁, A₂, A₃..... A_n are areas of polygons surrounding each station.

Isohyetal Method: Isohyets are imaginary line joining points of equal precipitation in each area like contours in each area.

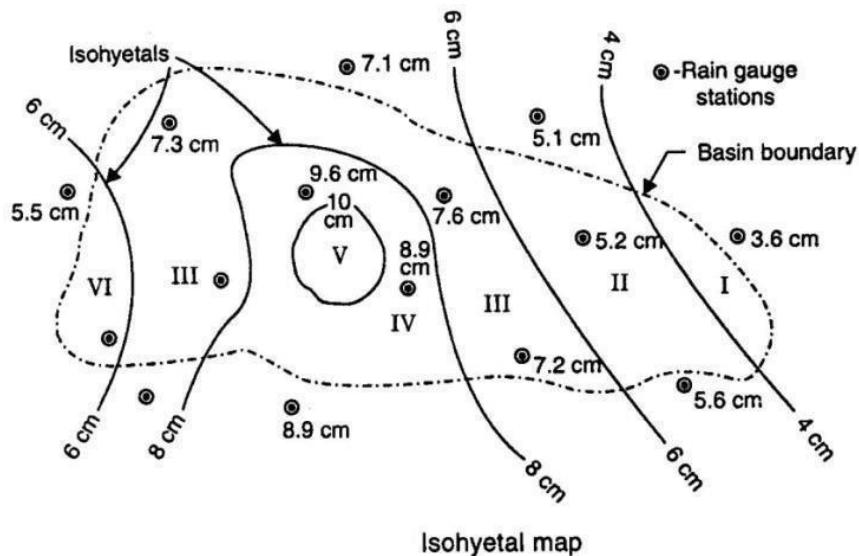

In Isohyetal Method for determining the average precipitation over an area, Isohyets of different values are sketched in a manner like contours in surveying in a given area. The mean (average) of two adjacent Isohyetal values is assumed to be the precipitation over the

(20A01603) HYDROLOGY AND IRRIGATION ENGINEERING
UNIT-I

area lying between the two isohyets. To get the average precipitation over an area the procedure to be followed is

- Each area between the isohyets is multiplied with the corresponding mean Isohyetal value (precipitation).
- All such products are summed up.
- The sum obtained from above is divided by the total area of the catchment (gauging area).
- The quotient obtained from above represents average precipitation over gauging area.

ESTIMATION OF MISSING PRECIPITATION RECORD

A sufficiently long precipitation record is required for frequency analysis of rainfall data. But a particular rain gauge may not be operative for some time due to many reasons it becomes necessary to estimate missing record & fill the gap rather than to leave it empty. This is done by the following method.

1. Interpolation from Isohyetal map

In an Isohyetal map of the area the position of the station (rain gauge) where record is missing is marked by interpolation techniques the missing record is worked out the factors like storm factor, topography nearness to sea is considered for proper estimation.

2. Station Year method

In this method the records of 2 or more stations are combined into one long record provided station records are independent and areas in which stations located are climatologically the same. The missing record at any station in a particular year may be found by ratio of averages or by graphical comparison.

3. Arithmetic average method

Here number of other rain gauge station record surrounding station in question (missing record) is required. The missing rainfall record at the station is taken as average of all available data surrounding station in question. $P_1, P_2, P_3, \dots, P_n$ are rainfall record from n station surrounding a non-operative station 'x' the rainfall data for station 'x' is given as

$$P_x = (P_1 + P_2 + P_3 + \dots + P_n) / n$$

This method is applicable when normal annual rainfall at station x does not differ by more than 10% with the surrounding station.

(20A01603) HYDROLOGY AND IRRIGATION ENGINEERING
UNIT-I

4. Normal ratio method

This method is applicable when normal annual rainfall at required station differ more than 10% of annual rainfall at surrounding station.

Let $P_1, P_2, P_3, \dots, P_n$ be rainfall record at 'n' station during a particular storm surrounding station 'x' (with missing record). Let N_1, N_2, \dots, N_n be annual normal rainfall for 'n' station. N_x be annual rainfall for station 'x'. Then the rainfall at station 'x' during a given storm is calculated as

$$P_x = 1/n (N_x/N_1 P_1 + N_x/N_2 P_2 + \dots + N_x/N_n P_n)$$

RAIN GAUGE DENSITY

The catchment area of a rain gauge is very small compared to the areal extent of a storm. It becomes obvious that to get a representative picture of a storm over a catchment, the number of rain gauges should be as many as possible. On the other hand, topographic conditions and accessibility restrict the number of rain gauges to be set up. Hence one aims at optimum number of rain gauges from which accurate information can be obtained. From practical considerations IMD as per IS 4987 has recommended the following rain gauge densities depending upon the type of area.

- Plain areas – 1 station per 520 km²
- Areas with 1000 m average elevation - 1 station per 260 to 350 km²
- Predominantly hilly areas with heavy rainfall - 1 station per 130 km²

OPTIMUM NUMBER OF RAIN GAUGE STATIONS

If there are already some rain gauge stations in a catchment, the optimal number of stations that should exist to have an assigned percentage of error in the estimation of mean rainfall is obtained by statistical analysis as

$$N = (C_v/E)^2$$

Where, N= optimal number of stations

E = allowable degree of error in the estimate of mean rainfall

If there are n stations in the catchment each recording rainfall values P_1, P_2, \dots, P_n in a known time, the coefficient of variation

$$C_v = 100\sigma/P$$

$$\sigma = \sqrt{\frac{n}{n-1} * [P^2 - P^2]}$$

$$P = (P_1 + P_2 + P_3 + \dots + P_n) / n$$

(20A01603) HYDROLOGY AND IRRIGATION ENGINEERING
UNIT-I

$$P^1 = (P_1^2 + P_2^2 + P_3^2 + \dots + P_n^2) / 3$$

TESTS FOR CONSISTENCY OF RAINFALL

If the conditions relevant to the recording of a rain gauge station have undergone significant change during the period of record, inconsistency could arise in the rainfall data of that record. Some of the common causes for inconsistency of record are:

1. Shifting the rain gauge station to new location.
2. The neighborhood of the station undergoing a marked change.
3. Change in the ecosystem due to calamities such as forest fires, land slide etc.
4. Occurrence of observational error from certain data.

Checking for inconsistency of a record is done by “double mass curve technique”. This technique is based on the principle that “when each recorded data comes from the same parent population, they are consistent.

A group of 5 to 10 base stations in the neighborhood of the problematic station ‘X’ is selected. The data of annual (monthly) mean rainfall of the station X and also the average rainfall of the group of the base stations covering a long period is arranged in reverse chronological order. The accumulated precipitation of station X and the accumulated precipitation values of the average of the group of base station are calculated starting from the latest record. Values of $\sum P_x$ are plotted against $\sum P_{avg}$ for various consecutive time periods. A decided break in the slope of the resulting plot indicate a change in precipitation regime of station ‘X’ beyond the period of change of regime is corrected by using the relation:

$$P_{C_x} = P_x \cdot \frac{M_c}{M_a}$$

Where, P_{C_x} = Corrected precipitation at any time period T_1 at station X

P_x = Original recorded precipitation at time period T_1 at station X

M_c = Corrected slope of the double mass curve

M_a = Original slope of the double mass curve

(20A01603) HYDROLOGY AND IRRIGATION ENGINEERING
UNIT-I

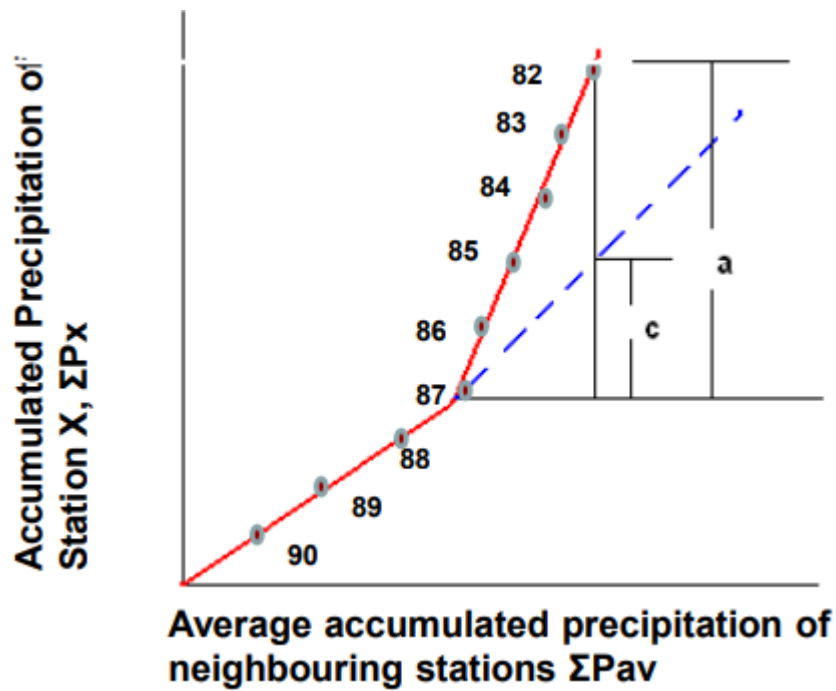

FIG: Double mass curve

PRESENTATION OF RAINFALL DATA

The Mass Curve of Rainfall

The mass curve of rainfall is a plot of the accumulated precipitation against time, plotted in chronological order. Records of float type and weighing bucket type gauges are of this form. A typical mass curve of rainfall at a station during a storm is shown in figure below. Mass curve of rainfall is very useful in extracting the information on the duration and magnitude of a storm. Also, intensities at various time intervals in a storm can be obtained by the slope of the curve. For non-recording rain gauges, mass curves are prepared from knowledge of the approximate beginning and end of a storm and by using the mass curve of adjacent recording gauge stations as a guide.

(20A01603) HYDROLOGY AND IRRIGATION ENGINEERING
UNIT-I

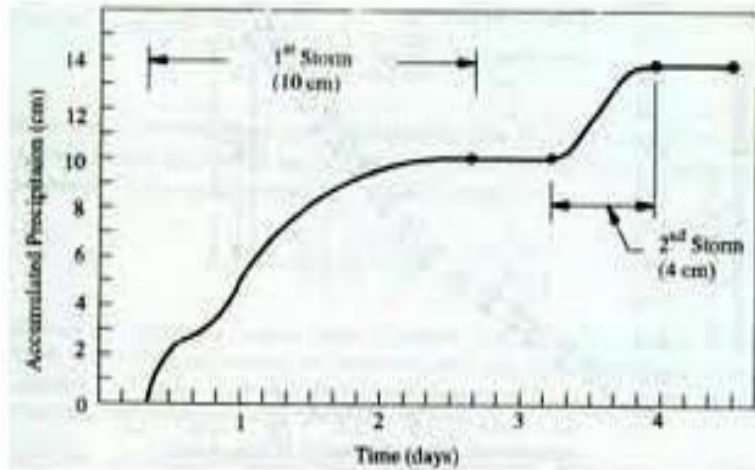

FIG: Mass Curve of Rainfall

Hyetograph

A hyetograph is a plot of the intensity of rainfall against the time interval. The hyetograph is derived from the mass curve and is usually represented as a bar chart. It is very convenient way of representing the characteristics of a storm and is particularly important in the development of design storms to predict extreme floods. The area under a hyetograph represents the total precipitation received in the period. The time interval used depends on the purpose, in urban drainage problems small durations are used while flood flow computations in larger catchments the intervals are about 6h.

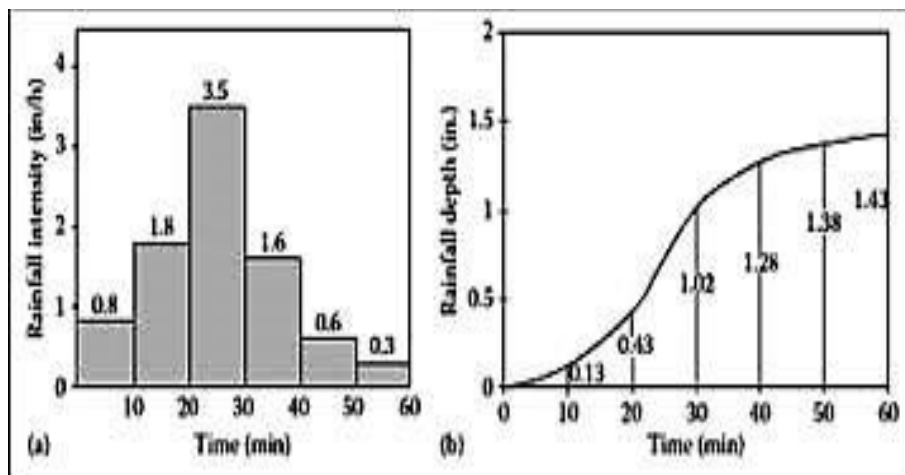

FIG: Hyetograph of a storm

Point rainfall

It is the total liquid form of precipitation or condensation from the atmosphere as received and measured in a rain gauge. It is expressed as so many 'mm' of depth of water.

(20A01603) HYDROLOGY AND IRRIGATION ENGINEERING
UNIT-I

Ordinate graph

The ordinate graph represents the rainfall in any year as an ordinate line drawn to some scale at the corresponding year.

Moving Average Curve

The graphical representation of rainfall in any of the above methods may not show any trend or cyclic pattern present in the data. The moving average curve smoothens out the extreme variations and indicate the trend or cyclic pattern if any more clearly. It is also known as the moving mean curve.

The procedure to construct the moving average curve is as follows:

The moving average curve is constructed with a moving period (m) year, where m is generally taken to be 3 to 5 years. Let $X_1, X_2, X_3, \dots, X_n$ be the sequence of given annual rainfall in the chronological order. Let Y_i denote the ordinate of the moving average curve for the i^{th} year. Then $m = 3$, Y_i is computed from

$$Y_2 = X_1 + X_2 + X_3 / 3$$

$$Y_3 = X_2 + X_3 + X_4 / 3$$

$$Y_i = X_{(i-1)} + X_i + X_{(i+1)} / 3$$

$$Y_{(n-1)} = X_{(n-2)} + X_{(n-1)} + X_n / 3$$

From the above equations the computed value of 'i' correspond in time, the middle value of 'x' being average and therefore it is convenient to use odd values of "m"

(20A01603) HYDROLOGY AND IRRIGATION ENGINEERING
UNIT-II

INTRODUCTION

When precipitation occurs on land, a part of it is intercepted by vegetation and some part of it is stored as depression storage. A part of precipitation infiltrates into the ground. The rate of infiltration depends on the nature of the soil, moisture content in soil, topography, etc. If the rate of precipitation is greater than the rate of infiltration, then the rainfall in excess of infiltration will start flowing over the ground surface and is also known as over land flow. When overland flow is occurring infiltration and evaporation may also occur. When over land flow reaches a well-defined stream it is known as surface run off. A portion of infiltrating water will satisfy soil-moisture deficiency. A portion may move in soil but very close to the surface. If this also reaches a well-defined stream it is known as inter flow or subsurface flow. Another portion of infiltration may percolate deeper into the soil to reach ground water table. Under favorable conditions some of the ground water may reach the streams and this portion is known as Base flow or ground water flow. A part of precipitation may occur directly on stream surface and this is known as channel Precipitation.

Hence, Total runoff = Surface run off + Inter flow + Base flow + Channel precipitation.

It is also evident that evaporation always occurs along with transpiration.

Hence, Precipitation = Run off + Evaporation

OR

Precipitation = (Surface run off + Inter flow + Base flow + Channel precipitation) +
Evaporation

DEFINITIONS

1. Total Run off: This is the part of precipitation which appears in streams. It consists of Surface run off, Inter flow, Base flow, and Channel precipitation.
2. Surface run off (SRO): This is the part of overland flow which reaches the streams.
3. Direct run off (DRO): It consists of Surface run off, Inter flow, and Channel precipitation, but does not include Base flow. Since channel precipitation is small and inter flow is uncertain, it is usual to include these two run offs in surface run off. Hence there is no difference between direct run off and surface run off. Hence Total run off = Surface run off + Base flow Since the base flow occurs in the stream after a longer time compared to surface run off, it is necessary to separate the base flow and surface run off in preparing hydrographs.
4. Hydrograph: A hydrograph is a plot of the run off or discharge in a stream versus time. Hydrographs may be developed for isolated or complex storms using stream gauging data. The area under the hydrograph gives the total volume of runoff and each ordinate gives the

(20A01603) HYDROLOGY AND IRRIGATION ENGINEERING
UNIT-II

discharge at the instant considered. It also indicates the peak discharge and the time base of the flood in the stream.

5. Rainfall excess: This is the portion of rainfall appearing in the stream as surface run off.

6. Effective rainfall: This is the portion of rainfall which appears in the stream as the sum of Surface run off, Inter flow, and Channel precipitation. Since channel precipitation is small and inter flow is uncertain, it is usual to include these two run offs in surface run off. Thus, rainfall excess and effective rainfall may be considered to be the same.

Note: Surface run off = Precipitation – (interception + depression storage + evaporation + infiltration)

7. Channel storage: As runoff occurs in the stream, the water level will rise along the length of the stream. Thus, a large volume of water is temporarily stored in the channel. This is known as channel storage. It reduces or moderates flood peaks. The channel storage therefore causes delay in the appearance of discharge at any section of the stream.

METHODS OF ESTIMATING RUN OFF FROM BASINS

The basin area contributing to the flow in a stream goes on increasing as we go down along a stream. Hence the section at which the flow is measured should be specified. The various methods for estimating run off from basins are

- a. Empirical formulae and charts
- b. By estimating losses (evaporation, transpiration, etc.)
- c. By infiltration
- d. Unit Hydrograph method
- e. Synthetic Unit Hydrograph method (Synder's method)

It is difficult to obtain even a fairly approximate estimate of run off because the various processes such as overland flow, base flow, infiltration, evaporation, etc are highly irregular and complex. Thus none of the above methods can be considered as accurate. However the Unit Hydrograph method is easier and is considered as the best among the methods mentioned.

(20A01603) HYDROLOGY AND IRRIGATION ENGINEERING
UNIT-II

HYDROGRAPH

A Hydrograph is a graph showing the variation of discharge versus time.

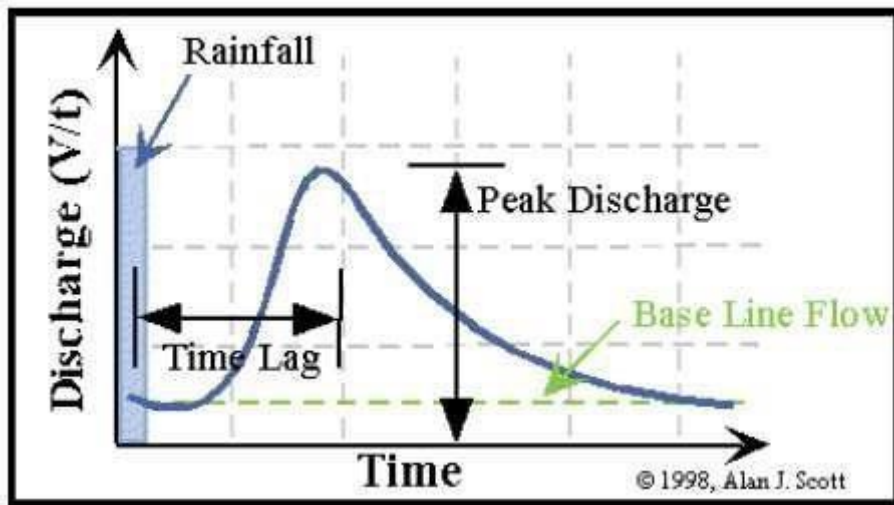

At the beginning there is only base flow (i.e., the ground water contribution to the stream) gradually deflecting in a conical form. After the storm commences, the initial losses like interception and infiltration are met and then the surface flow begins. The hydrograph gradually rises and reaches its peak value after a time t_p (log time or basin lag) measured from the centroid of the hydrograph of the net rain. Thereafter it declines and there is a change of slope at the inflection point i.e., there has been inflow of the rain up to this point and after this there is gradual withdrawal of catchment storage. Thereafter the GDT declines and the hydrograph again goes on depleting in the exponential form called the ground water depletion curve or the recession curve.

HYDROGRAPH WITH MULTIPLE PEAKS

Basic definitions (Hydrograph features):

- a) Rising limb: It is the curve or line joining the starting point 'A' of the raising curve and the point of reflection. The shape of the raising line is influenced by the rainfall characteristics.
- b) Peak or Crest: It represents the highest point/position of the hydrograph. Its duration also depends on the intensity and duration of the rainfall.
- c) Falling limb or depletion curve: It is the descending portion of the hydrograph. The shape of the falling limb is mainly a function of the physical features of the channel alone and is independent of storm characteristics (it depends on basin characters).
- d) Time to peak (t_p): It is the time to peak from the starting point of hydrograph
- e) Lag time: The time interval from the centre of mass of rainfall to the centre of mass hydrograph is the lag-time.

(20A01603) HYDROLOGY AND IRRIGATION ENGINEERING
UNIT-II

f) It is the total duration or time elapsed between the starting and ending of the hydrograph.

FACTORS AFFECTING THE SHAPE OF THE FLOOD HYDROGRAPH

a) Climatic factors

b) Physical factors

➤ Climatic factors include

- 1) Storm characteristics, intensity, duration, magnitude and movement of storm
- 2) Initial loss due to interception etc.
- 3) Evapotranspiration

➤ Physical factors include

- 1) Basic characteristics, shape, size, slope, nature of the valley, elevation, drainage density
- 2) Infiltration characteristics, land use and cover, soil type, geological conditions etc.
- 3) Channel characteristics, cross section, roughness and storage capacity

(For a given duration, the peak and volume of surface runoff are essentially proportional to the rainfall intensity. Duration of rainfall of given intensity directly effects the volume of runoff. If the storm moves in the downstream direction flow will be quicker at the basin. Smaller catchments yield a more rapid and intense flood per unit area. Vegetation and forests increase infiltration and also the storage capacity of the soils; vegetal cover reduces the peak flow.

UNIT HYDROGRAPH

A unit hydrograph is defined as the hydrograph of direct runoff resulting from one cm depth excess rainfall occurring uniformly over the basin and at a uniform rate for a specified duration.

Assumptions:

1. The effective rainfall is uniformly distributed within the specified period of time or within its duration
2. The time or base duration of the hydrograph of direct runoff due to an effective rainfall of unit duration shall be constant.
3. The effective rainfall is uniformly distributed throughout the area of drainage basin.
4. The direct runoff of common base line are proportional to the total amount of direct runoff.
5. The hydrograph of runoff due to a given period of rainfall for a drainage area shows all the combined physical characteristics.

(20A01603) HYDROLOGY AND IRRIGATION ENGINEERING
UNIT-II

Limitations of Unit hydrograph theory:

1. Unit hydrograph is based on the assumption that effective rainfall is uniform over the entire basin. However, it is seldom true particularly in the case of large basin. As such unit hydrograph theory is limited to the basins of size not exceeding 6000 km². Thus, large basins should be subdivided & unit hydrograph should be separately developed for each basin.
2. This theory is not applicable when approachable quantity of precipitation occurs in the form of snow.

Derivation:

1. Few unit periods of intense rainfall duration corresponding to an isolated storm uniformly distributed over the area are collected from the past rainfall records.
2. From the collected past records of the drainage for the forms prepare the storm hydrograph for some days after and before the rainfall of that unit duration.
3. Draw the line reporting the ground water flow and direct runoff by any of the standard base flow separation procedures.
4. From the ordinate of the total runoff hydrograph deduct the corresponding ordinates of base flow to obtain the ordinates of direct runoff.
5. Divide the volume of direct runoff by the area of the drainage basin to obtain the net precipitation depth(x) over the basin.
6. Divide each of the ordinates of direct runoff by net precipitation depth to obtain the ordinates of the unit hydrograph. i.e., ordinate of unit hydrograph (UHG) = Ordinate of direct runoff / (FHG)/Depth of net precipitation(x) i.e, $UHG = FHG/x$
7. Plot the ordinates of the unit hydrograph against time since the beginning of direct runoff, which is the unit hydrograph for the basin for the duration of the storm.

HYDROGRAPH SEPARATION/BASE FLOW SEPARATION:

In figure: By simply drawing a line 'AC' tangential to both the limbs at their lower portion. This method is very simple but is approximate and can be used only for preliminary estimates.

2. Extending the recession curve existing prior to the occurrence of the storm up to the point 'D' directly under the peak of the hydrograph and then drawing a straight-line DE. Where E is a point hydrograph 'N' days after the peak & N (in days) is given by $N = 0.8f$
- 3 Where A is the area of drainage basin (km²) & the size of the areas of the drainage basin as a

(20A01603) HYDROLOGY AND IRRIGATION ENGINEERING
UNIT-II

guide to the values of 'N' are given below: Area of drainage basin, km Time after peak N
(days) Simply by drawing a straight-line AE, from the point of rise to the point E on the
hydrograph, 'N' days after the peak. By producing a point on the recession curve backwards
up to a point 'F' directly below the inflection point and the joining a straight-line AF.

(20A01603) HYDROLOGY AND IRRIGATION ENGINEERING
UNIT-III

INTRODUCTION

Irrigation may be defined as the process of artificially supplying water to the soil for raising crops. It is a science of planning and designing an efficient low-cost irrigation system to suite the natural conditions. It is the engineering of controlling and harnessing the various natural sources of water by the construction of dams and reservoirs, canals and head works finally distributing the water to the agricultural fields. Irrigation engineering includes the study and design of works connected with river control, drainage of water-logged areas and generations of hydroelectric power.

Necessity or Importance of Irrigation

India is basically an agricultural country and its resources on depend on the agricultural output. Prosperity of our country depends mainly upon proper development of agriculture. Even after 60 years of Independence, we have not succeeded in solving our food problems. The main reason for this miserable state of affair is that we still continue to remain at the mercy of rain and practice age old methods of cultivation. Plants usually derive water from nature through rainfall. However, the total rainfall in a particular area may be either insufficient or ill timed. In order to get the maximum yield, it is necessary to have a systematic irrigation system for supplying optimum quantity of water at correct timing.

Importance of irrigation can be summarized under the following four aspects:

1. Area of less rainfall: Artificial supply of water is necessary when the total rainfall is less than the water requirement of crops in such cases, irrigation works may be constructed at a place where more water is available and conveyed to water deficit areas.

Eg: The Rajasthan canal supplies water from the river Yamuna to the arid regions of Rajasthan where annual rainfall is less than 100 to 200 mm.

2. Non-Uniform rainfall: The rainfall in a particular area may not be uniform over the entire crop period. Rainfall may be there during the early period of crops and may become scanty or unavailable at the end resulting in lesser yield or total loss of the crop. Collection of water during periods of excess rainfall and supplying the stored water during periods of scarcity may prove beneficial to the farmers. Most irrigation projects in India are based on this aspect.

3. Commercial crops with additional water: The rainfall in a particular area may be sufficient to raise the usual crops but insufficient for raising commercial and cash crops such as sugarcane and cotton. In such situations, utilizing stored water by irrigation facilities is advantageous.

(20A01603) HYDROLOGY AND IRRIGATION ENGINEERING
UNIT-III

4. Controlled Water Supply: Dams are normally meant for storing water during excess flow periods. But in situations of heavy rainfall, flooding can be controlled by arresting the flow in the river and excess water can be released during low flow conditions.

Benefits of Irrigation:

There are many direct and indirect benefits or advantages of irrigation which can be listed as follows.

1. Increase in food production: Crops need optimum quantity of water at required intervals assured and timely supply of water helps in achieving good yield and also superior crops can be grown and thus, the value of the crops increases.
2. Protection from famine: Irrigation works can be constructed during famine (drought). This helps in employment generation and people also get protection from famine. After completion of such works, continuous water supply may be available for crops and people.
3. Cultivation of Cash crops: With the availability of continuous water supply, cash crops such as sugarcane, indigo, tobacco, cotton etc. can be grown.
4. Increase in prosperity of people: Due to assured water supply people can get good yield and returned for their crops. Land value increases and this raises the standard of living of the people and hence prosperity takes place.
5. Generation of hydroelectric power: Major River valley projects are designed to provide power generation facilities also apart from irrigation needs.
6. Domestic and Industrial water supply: Water stored in reservoirs can also be used to serve other purposes like domestic water supply to towns and cities and also for industrial use. Canals can also be effectively used to serve these purposes.
7. Inland Navigation: In some cases, the canals are very large enough to be used as channels for inland navigation as water ways are the cheapest means of transportation.
8. Improvement in communication: Main canals in large irrigation projects are provided with inspection roads all along the sides. These roads can be asphalted and used as a means of communication.
9. Canal plantation: Due to continuous flow of water adjoining areas of a canal are always saturated with water. In such places, trees can be planted which increases the timber wealth of the country.
10. Improvement in ground water storage: Due to constant percolation and seepage of irrigation water, ground water table rises. The ground water may percolate and may be beneficial to other areas.

(20A01603) HYDROLOGY AND IRRIGATION ENGINEERING
UNIT-III

11. Aid in civilization: Due to introduction of river valley projects, tribal people can adopt agriculture as their profession which helps in improving the standards of living.

12. General development of a country: By assured water supply, farmers can expect good yield. By exporting surplus goods, Government can get revenue. The government can then come forward to improve communications facilities such as roads and railways and also social development by providing schools, hospitals etc.,

ILL-EFFECTS OF IRRIGATION

If water is used in a controlled and careful manner, there would be no ill effects of irrigation. Excess and unscientific use of irrigation of water, gives rise to the following ill effects.

1. Water logging: Excess water applied to the fields allows water to percolate below and ground water table rise. The ground water table may rise saturating the root zone of the crop and cutting of air supply to the roots of the crops. Such a phenomenon is called water logging. Under such conditions fertility of land reduced and also reduction of crop yield.

2. Breeding place for mosquitoes: Excess application of water for irrigation leads to water logging and formation of stagnant water pools, which become breeding places for mosquitoes, thus helping spreading of malaria.

3. Unhealthy Climate: Due to intense irrigation the climate becomes damp during summer due to humidity, the climate is sultry and in winter it becomes excessively cold. The resistance of the body to diseases is reduced. In addition to the above, careless use of water leads to wastage of useful irrigation water for which any government will have incurred huge amounts.

TYPES OR SYSTEMS OF IRRIGATION

Lift Irrigation: It is that system of irrigation in which irrigation water is available at a level lower than that of the land to be irrigated and hence water is lifted by pumps or other mechanism (Hydraulic ram and siphon action) and then conveyed to agriculture fields by gravity flow. Irrigation through wells is an example of lift irrigation. Water from canals or any other source can also be lifted when the level of water is lower than that of the area to be irrigated.

Inundation Irrigation: It is that system of irrigation in which large quantity of water flowing in a river is allowed to flood or inundate the fields to be cultivated. The land becomes thoroughly saturated. Excess water is drained off and the land is prepared for cultivation. Moisture stored in the soil is sufficient to bring the crop to maturity. Inundation irrigation is

(20A01603) HYDROLOGY AND IRRIGATION ENGINEERING
UNIT-III

commonly practiced in delta region of rivers. Canals may be also employed to inundate the fields when water is available in plenty.

Perennial Irrigation: It is that system of irrigation in which irrigation water is supplied as per the crop requirements at regular intervals throughout the crop period. The source of irrigation water may be a perennial river, stored water in reservoirs or ground water drawn from open wells or bore wells. This is the most commonly adopted irrigation system.

Direct Irrigation: It is a type of flow irrigation in which water from rivers and streams are conveyed directly to agricultural fields through a network of canals, without making any attempt to store water this is practiced in areas where the rivers and streams are perennial. Small diversion dams or barrages may be constructed across the rivers to raise the water level and then divert the water into canals.

Storage Irrigation: Dams are constructed across rivers which are non-perennial. The discharge in such rivers may be very high during rainy season and may become less during dry stream. By constructing dams across such rivers water can be stored as reservoir during excess flow and can be utilized or diverted to agriculture fields through canals as and when required. Such a system is known as storage irrigation.

BANDHARA IRRIGATION

It is a special irrigation scheme adopted across small perennial rivers. This system lies somewhere between inundation type and permanent type of irrigation. A Bandhara is a low masonry weir (obstruction) of height 1.2m to 4.5m constructed across the stream to divert water into a small canal. The canal usually takes off from one side and the flow into the canal is controlled by a head regulator.

The length of the main canal is usually restricted to about 8km. A series of Bandharas may be constructed one below the other on the same stream so that water spilling over from one Bandhara is checked by another Bandhara. The irrigation capacity of each Bandhara is may be about 400 hectares. Bandharas are adopted across small streams having isolated catchments which are considered to be non-feasible or uneconomical to be included under a large irrigation scheme.

This method of irrigation is followed in Central Maharashtra and is commonly known there as the 'Phad' system.

Advantages of Bandharas:

1. Small quantity of flow in streams can be fully utilized or otherwise might have gone as a waste.

(20A01603) HYDROLOGY AND IRRIGATION ENGINEERING
UNIT-III

2. As the length of the canal is short, seepage and evaporation losses are less.
3. Intensive irrigation with high duty may be achieved and the area to be irrigated is close to the source
4. The initial investment and maintenance cost of the system is low.

Disadvantages of Bandharas:

1. The supply of water is unreliable when the flow in streams becomes lesser.
2. Excess water available cannot be utilized as area for cultivation below each Bandhara is fixed.
3. In dry seasons, people living on the downstream side of Bandharas may be deprived of water for domestic made also.

WATER REQUIREMENT OF A CROP

It is the total quantity of water required by the crop from the time it is sown to the time it is harvested. Different crops require different quantities of water. Since the growing crops use water continuously, it is essential to maintain the quantity of readily available moisture in the soil by irrigation. As such the total quantity of water required by a crop is so distributed that a part of it is applied each time at a more or less fixed interval throughout the period of growth. The quantity of water applied at each irrigation should be such that water sufficient to meet the needs of the crop for a period between two successive irrigations is stored in the soil. Therefore, in addition to the total quantity of water required by a crop, it is also essential to determine the frequency of irrigation as well as the quantity of water required to be applied during each application.

DEFINITIONS

Duty of Water:

Duty represents the irrigating capacity of a unit of water.

It is usually defined as the area of land in hectares which can be irrigated to grow a crop of the cumec of water is continuously supplied for the entire period of the crop.

Delta:

It is the total depth of water required by a crop during the entire crop period and is denoted as 'Δ'

Crop Period or Base Period

The time period that elapses from the instant of its sowing to the instant of its harvesting is called the crop period.

The time between the first watering of a crop at the time of its sowing to its last watering before harvesting is called the base period or the base of the crop.

Crop period is slightly more than the base period, but for all practical purposes, they are taken as one and the same thing and generally expressed in days.

Relation between Duty(D) and Delta(Δ)

Let there be a crop of base period B days. Let one cumec of water be applied to this crop on the field for B days. Now, the volume of water applied to this crop during B days.

Volume of water applied to crop = $V = (1 \times 60 \times 60 \times 24 \times B) \text{ m}^3 = 86400 B$ (cubic meter) By duty (D) definition, one cubic meter supplied for B days matures D hectares of land. This quantity of water (V) matures D hectares of land or $104 D \text{ sq.m}$ of area.

Total depth of water applied on this land = $\text{Volume} / \text{Area} = 86,400 B / 104 D = 8.64B/D$ metres

By definition, this total depth of water is called delta (Δ). So, $\Delta = 8.64 B/D$ (metres)

Where

- Δ is in meters, B is in days; and
- D is duty in hectares/cumec.

Types of Irrigation Efficiencies

Efficiency is the ratio of the water output to the water input and is usually expressed as a percentage. Input minus output is nothing but losses; hence, if losses are more, the output is less, and efficiency is less. Hence, efficiency is inversely proportional to the losses. Water is lost in irrigation during various processes; therefore, there are different kinds of irrigation efficiencies, as given below.

(i) Efficiency of water-conveyance (η_c): It is the ratio of the water delivered into the fields from the outlet point of the channel to the water pumped into the channel at the starting point. It may be represented by η_c . It takes the conveyance or transit losses into account.

(ii) Efficiency of water application (η_a): It is the ratio of the quantity of water stored in the root zone of the crops to the quantity of water delivered into the field. It may be represented by η_a . It may also be termed farm efficiency, as it considers the water lost on the farm.

(iii) Efficiency of water storage (η_s): It is the ratio of the water stored in the root zone during irrigation to the water needed in the root zone before irrigation (i.e., field capacity)

–existing moisture content). It may be represented by η_s .

(iv) Efficiency of water use (η_u): It is the ratio of the water beneficially used, including leaching water, to the quantity of water delivered. It may be represented by η_u .

(v) Uniformity coefficient or Water distribution efficiency

The effectiveness of irrigation may also be measured by its water distribution efficiency (η_d), which is defined below:

$$\eta_d = (1-d/D) \times 100$$

Where

- η_d = Water distribution efficiency
- D = Mean depth of water stored during irrigation.
- d = Average of the absolute values of deviations from the mean.

The water distribution efficiency represents the extent to which the water has penetrated to a uniform depth throughout the field. When the water has penetrated uniformly throughout the field, the deviation from the mean depth is zero, and the water distribution efficiency is 1.0.

(vi) Consumptive Use or Evapotranspiration (C_u)

Consumptive use for a particular crop may be defined as the total amount of water used by the plant in transpiration (building of plant tissues, etc.) and evaporation from adjacent soils or plant leaves at any specified time. The values of consumptive use (C_u) may differ for different crops and for the same crop at different times and places.

In fact, the consumptive use for a given crop at a given place may vary throughout the day, the month, and the crop period. Values of daily or monthly consumptive use are generally determined for a given crop and at a given place. Values of monthly consumptive use over the entire crop period are then used to determine the irrigation requirement of the crop

Concept of Consumptive Irrigation Requirement (CIR)

It is the amount of Irrigation water required to meet the evapotranspiration needs of the crop during its full growth. Therefore, it is nothing but the consumptive use itself, exclusive of effective precipitation, stored soil moisture, or groundwater. When the last two are ignored, then we can write

$$\mathbf{CIR = C_u - R_e}$$

Effective Rainfall (R_e)

Precipitation falling during the growing period of a crop that is available to meet the evapotranspiration needs of the crop is called effective rainfall. It does not include

precipitation lost through deep percolation below the root zone or the water lost as surface runoff.

Net Irrigation Requirement (NIR)

It is the amount of irrigation water required in order to meet the evapotranspiration need of the crop as well as other needs such as leaching. Therefore, $N.I.R. = C_u - R_e + \text{Water lost as percolation in satisfying other needs such as leaching.}$

Consumptive use or evapotranspiration depends upon all those factors on which evaporation and transpiration depend, such as temperature, sunlight, humidity, wind movement, etc

Estimation of Consumptive Use

Although various methods have been developed in order to estimate the evapotranspiration (consumptive use) value of a crop in an area, the most simple and commonly used methods are:

- (1) Blaney–Criddle Equation, and
- (2) Hargreaves class a pan evaporation method

Blaney-Criddle Formula

It states that the monthly consumptive use is given by

$$C_u = (K.P/40) [1.8t + 32]$$

where

- C_u = Monthly consumptive use in cm.
- k = Crop factor, determined by experiments for each crop under the environmental conditions of the particular area.
- t = Mean monthly temperature in °C
- p = Monthly per cent of annual daylight hours that occur during the period.

If $p/40 [1.8t + 32]$ is represented by f , we get

$$C_u = k.f$$

Example : If wheat requires about 7.5 cm of water after every 28 days, and the base period for wheat is 140 days, find out the value of the delta for wheat.

Solution: Assuming the base period represents the crop period, as per usual practice, we can easily infer that the water is required at an average interval of 28 days up to a total period of 140 days.

This means that $5(140/28)$ no. of waterings are required 28 days The

depth of water required each time = 7.5 cm.

The total depth of water required. In 140 days = $5 \times 7.5 = 37.5$ cm

Hence, Δ for wheat = 37.5 cm

Example : 10 cumecs of water are delivered to a 32-hectare field for 4 hours. Soil probing indicated that 0.3 metres of water has been stored in the root zone. Compute the water application efficiency.

Solution: Volume of water supplied by 10 cumecs of water applied for 4 hours = $(10 \times 4 \times 60 \times 60) \text{m}^3 = 1,44,000 \text{m}^3$

= $14.4 \times 10^4 \text{m}^3 = 14.4 \text{m} \times 10^4 \text{m}^2 = 14.4 \text{ ha.m}$.

Depth of water applied =

volume/area = $1,44,000/32,0,000 = 144/320 = 0.45$

Input = 14.4 ha.m

Output = 32 hectares of land storing water upto 0.3 m depth,

Output = $32 \times 0.3 \text{ ha.m} = 9.6 \text{ ha.m}$

Water application efficiency (η_a) = $\text{Output/ Input} \times 100 = (9.6/14.4) \times 100 = 67$

(20A01603) HYDROLOGY AND IRRIGATION ENGINEERING
UNIT-IV

CANALS

A canal is an artificial channel, generally trapezoidal in shape, constructed on the ground to carry water to the fields either from a river or tank or reservoir.

If the full supply level (FSL) of a canal is below the natural ground surface, an open cut or excavation is necessary to construct a canal. If the FSL of the canal is above the existing ground level, the canal is constructed by providing earthen banks on both sides. In the first case the channel is called a canal in cutting and in the second case it is called a canal in filling. Sometimes a canal can be of the intermediate type and the channel is called a canal in partial cutting and Partial filling.

CLASSIFICATION OF CANALS:

The irrigation canals can be classified in different ways based on the following considerations.

1. Classification based on the nature of source of supply:

a) Permanent canals

b) Inundation canals

- A permanent canal is one which draws water from a permanent source of supply. The canal in such cases is made as a regular graded canal (fixed slope). It is provided with permanent regulation and distribution works. A permanent canal may also be perennial canal or nonperennial canal depending on whether the source supplying water is a perennial one or a nonperennial.
- An inundation canal is one which draws water from a river when the water level in the river is high or the river is in floods. These canals are not provided with any regulatory works, but an open cut is made in the banks of the canal to divert water.

2. Classification based on the function of the canal:

a) Feeder canals

b) Carrier canals

c) Navigation canals

d) Power canals

- A feeder canal is constructed for the purpose of supplying water to two or more canals only but not directly irrigating the fields.
- A carrier canal carries water for irrigating the fields and also feeds other canals for their needs.

(20A01603) HYDROLOGY AND IRRIGATION ENGINEERING
UNIT-IV

- A canal serving the purpose of in-land navigation is called a navigation canal.
- A power canal supplies water to a hydroelectric power generation plant for generation of electrical power.

3. Classification based on the discharge and its relative importance in a given network of canals:

- a) Main canal
- b) Branch canal
- c) Major distributory
- d) Minor distributory
- e) Water course or Field channel

- A main canal is the principal canal in a network of irrigation canals. It directly takes off from a river, reservoir, or a feeder canal. It has large capacity and supplies water to branch canals and even to major distributaries.
- Branch canals take off from a main canal on either side at regular intervals. They carry a discharge of about 5 cumec and are not usually used to directly irrigate the fields.
- A major distributory takes off a branch canal or a main canal. It has a discharge capacity of 0.25 to 5 cumec. They are used for direct irrigation and also to feed minor distributaries.
- Minor distributaries are canals taking off from the branch canals and major distributaries. They carry a discharge less than 0.25 cumec. These canals supply water to field channels.
- A water course or field channel takes off from either a major or minor distributory or a branch canal also. These are constructed and maintained by the cultivators/farmers. The other canals are constructed and maintained by the government or the Command Area Development Authority.

4. Classification based on Canal alignment:

- a) Ridge canal or watershed canal
- b) Contour canal
- c) Side slope canal

- A Ridge canal or watershed canal is one which runs along the ridge or watershed line. It can irrigate the fields on both sides. In case of ridge canals the necessity of cross drainage works does not arise as the canal is not intercepted by natural streams or drains.

(20A01603) HYDROLOGY AND IRRIGATION ENGINEERING
UNIT-IV

- A contour canal is one which is aligned nearly parallel to the contours of the country/area. These canals can irrigate the lands on only one side. The ground level on one side is higher and hence bank on the higher side may not be necessary.
- A contour canal may be intercepted by natural streams/drains and hence cross drainage works may be essential.
- A Side slope canal is one which is aligned at right angles to the contour of the country/area. It is a canal running between a ridge and a valley. This canal is not intercepted by streams and hence no cross-drainage works may be essential. This canal has steep bed slope since the ground has steep slope in a direction perpendicular to the contours of the country/area.

5. Classification based on the financial output:

- a) Productive canals
- b) Protective canals

- A productive canal is one which is fully developed and earns enough revenue for its running and maintenance and also recovers the cost of its initial investment. It is essential the cost of its initial investment is recovered within 16 years of construction.
- Protective canals are those constructed at times of famine to provide relief and employment to the people of the area. The revenue from such a canal may not be sufficient for its maintenance. The investment may also not be recovered within the stipulated time.

6. Classification based on the soil through which they are constructed:

- a) Alluvial canals
- b) Non-alluvial canals.

- Canals constructed in alluvial soils are known as alluvial canals. Alluvial soils are found in the Indo-Gangetic plains of North India. The alluvial soils can be easily scoured and deposited by water.
- Canals constructed through hard soils or disintegrated rocks are called non-alluvial canals. Such soils are usually found in Central and South India.

(20A01603) HYDROLOGY AND IRRIGATION ENGINEERING
UNIT-IV

7. Classification based on lining being provided or not:

a) Unlined canals

b) Lined canals

- An unlined canal is one which the bed and banks of the canal are made up of natural soil through which it is constructed. A protective lining of impervious material is not provided. The velocity of flow is kept low such that bed and banks are not scoured.
- A lined canal is one which is provide with a lining of impervious material on its banks and beds, to prevent the seepage of water and also scouring of banks and bed. Higher velocity for water can be permitted in lined canals and hence cross sectional area can be reduced.

CANAL ALIGNMENT

In aligning an irrigation canal, the following points must be considered.

1. An irrigation canal should be aligned in such a way that maximum area is irrigated with least length of canal.
2. Cross drainage works should be avoided as far as possible, such that the cost is reduced.
3. The off taking point of the canal from the source should be on a ridge, such that the canal must run as a ridge canal and irrigate lands on both sides.
4. Sharp curves in canals must be avoided.
5. In hilly areas, when it is not possible to construct ridge canals, the canal must be made to run as a contour canal.
6. The canal should be aligned such that the idle length of the canal is minimum.
7. The alignment should be such that heavy cutting or heavy filling are avoided. If possible balanced depth of cutting and filling is achieved.
8. It should not be aligned in rocky and cracked strata.
9. The alignment should avoid villages, roads, places of worship and other obligatory points.

DRAW BACKS IN KENNEDY'S THEORY:

1. Kutters equation is used for determining the mean velocity of flow and hence the limitations of kutter's equation are incorporated in Kennedy's theory.
2. The significance of B/D ratio is not considered in the theory
3. No equation for the bed slope has been given which may lead to varied designs of the channel with slight variation in the bed slope.

4. Silt charge and silt grade are not considered. The complex phenomenon of silt transportation is incorporated in a single factor are called critical velocity ratio.
5. The value of m is decided arbitrarily since there is no method given for determining its value.
6. This theory is aimed to design only an average regime channel.
7. The design of channel by the method based on this theory involves trial and error which is quite cumbersome.

DRAW BACKS IN LACEY'S THEORY:

1. The theory does not give a clear description of physical aspects of the problem.
2. It does not define what actually governs the characteristics of an alluvial channel.
3. The derivation of various formulae depends upon a single factor f and dependence on single factor f is not adequate.
4. There are different phases of flow on bed and sides and hence different values of silt factor for bed and side should have been used.
5. Lacey's equations do not include a concentration of silt as variable.
6. Lacey did not take into account the silt left in channel by water that is lost in absorption which is as much as 12 to 15% of the total discharge of channel.
7. The effect of silt accumulation was also ignored. The silt size does actually go on decreasing by the process attrition among the rolling silt particles dragged along the bed.
8. Lacey did not properly define the silt grade and silt charge.
9. Lacey introduced semi ellipse as ideal shape of a regime channel which is not correct.

Waterlogging

Introduction:

Waterlogging occurs when the soil is saturated with water. The agricultural land becomes waterlogged when the soil pores within the root zone of the crops get saturated and the normal conditions circulation of air is cutoff. The waterlogging affects the productivity of the land and leads to a reduction in the crop yield. Waterlogging generally occurs because of over-irrigation, high water table and the poor water management.

Due to the presence of water at or near the land surface, evaporation takes place continuously. Because of evaporation, there is a continuous upward flow of water from the water table if it is high because of the capillary action. Water brings salts with it and when the water evaporates, these salts get accumulated on the surface. These salts affect the fertility of the soil, and the soil may become alkaline. Waterlogging can be prevented to a large extent by providing an effective drainage system.

Causes of waterlogging:

Waterlogging of the land occurs when the water table rises and the soil in the root zone of the plants gets saturated and the air circulation is stopped. Waterlogging generally occurs because of intensive irrigation and inadequate drainage of the irrigated land. Waterlogging affects the productivity and the fertility of the land and causes a reduction in the crop yield. The causes of waterlogging are:

- 1. Over-Irrigation:** The main cause of waterlogging is over-irrigation of the land. The excess water applied to the land percolates deep into the ground and joins the water table. As the ground water storage is augmented, the water table rises. As soon as the water table comes close to the land surface, waterlogging occurs.
- 2. Inadequate surface drainage:** Waterlogging usually occurs when there is inadequate surface drainage of the irrigated land. Heavy precipitation along with inadequate surface drainage causes flooding of the land. The prolonged flooding (or inundation) results in heavy percolation of water into the ground, which causes a rise of the water table and hence waterlogging.
- 3. Obstruction of natural surface drainage:** If a natural drainage (stream) near the irrigated area is obstructed by constructing an embankment for a road, canal, etc., the flooding of the area may occur leading to waterlogging.
- 4. Obliteration of a natural drainage:** If an existing natural drainage is destroyed, it results in stoppage of natural flow and hence waterlogging.

5. Obstruction of natural subsurface drainage: If there is an impermeable stratum below the land surface at a relatively low depth, it prevents natural downward movement of water into the subsoil which may result in the formation of perched water table that can cause waterlogging.

6. Impervious top layer: If the top layer of the land is impervious, it obstructs the flow in the downward direction. Such land is prone to waterlogging due to irrigation.

7. Seepage from canals: Water Seeps from the bed and sides of an unlined canal. It adds to the ground water reservoir and there is a general rise in the water table, which may lead to waterlogging.

8. Construction of a reservoir: If a large reservoir is constructed in the region, there is an increase in the water level on the upstream of the dam. Consequently, there is an increase in the inflow to the groundwater storage and a decrease in the outflow from the groundwater as base flow of the river. The adjoining area may get waterlogged.

9. Defective methods of cultivation: If the defective methods of cultivation are used, there may be ponding up of water on the land surface which may cause waterlogging. The defective methods of cultivation include construction of high levees (bunds) which obstruct the natural drainage, inadequate preparation of land, failure to smoothen the field after tillage, improper disposal of spoil earth, improper selection or crops and growing crop which require excessive watering.

10. Defective irrigation practice: Waterlogging may also occur due to defective irrigation practice, such as adopting high intensity of irrigation, applying high depth of water and using defective method of application of water like wild flooding.

Ill effects of waterlogging:

1. Reduction in growth of plants: Because of waterlogging, there is absence of aeration in the roots of plants due to which the plant growth is reduced.

2. Difficulty in cultivation: For optimum results in crop production, the land has to be prepared. The preparation of land in wet condition is difficult and expensive. As a result, cultivation may be delayed and the crop yield adversely affected.

3. Accumulation of salts: As a result of high-water table in waterlogged areas, there is an upward capillary flow of water to the land surface where water gets evaporated. The upward moving water brings with it soluble salts from the salty soil layers well below the surface. These soluble salts carried by the upward moving water are left behind in the root zone when this water evaporates. The accumulation of these salts in the root zone of the soil may affect the crop yield considerably.

4. Weed growth: There are certain types of plants and grasses which grow rapidly in marshy lands. In waterlogged lands, these plants compete with the desired useful crop. Thus, the yield of the desired useful crop is adversely affected.

5. Increase in plant diseases: Because of waterlogging, various diseases occur in the plants, which decrease their growth.

6. Lowering of soil temperature: The presence of excessive moisture content lowers the temperature of the soil. In low temperature the bacteriological activities are retarded which affects the crop growth badly.

7. Increase in incidence of malaria: The waterlogged land becomes a breeding place for mosquitoes which may cause malaria. Moreover, the climate becomes damp which may affect the health of community.

Measures for prevention of waterlogging:

The main cause of waterlogging in an area is the introduction of canal irrigation in the area. It is; therefore, better to plan an irrigation scheme in such a way that the land is prevented from getting waterlogged. The following measures are usually adopted for prevention of waterlogging or relieving the area, which are waterlogged.

1. Limiting the intensity of irrigation: In regions where there is a possibility of waterlogging, the annual intensity of irrigation should be kept low, not more than 40 to 60%.

2. Providing a drainage system: Waterlogging can be prevented by providing a properly designed drainage system.

3. Lining the canal section: When the canal section is made fairly watertight by providing lining, the seepage loss is reduced to quite a good extent.

4. By lowering the FSL of the canal: Loss may be due to percolation or absorption but when FSL is lowered the loss is reduced to sufficient extent. The canal should be designed such that its FSL is as low as possible, consistent with the requirements of flow irrigation for the commanded area.

5. Improving the natural drainage of the area: Improving the natural drainage involves removing obstruction to the flow such as weeds, bushes and other vegetations from the stream section. Straightening of the streams and canalizing them into shallow wide reaches improves the natural drainage. Increasing the bed slopes of the streams also improves the drainage. The chances of waterlogging are considerably reduced if the natural drainage of the area is good.

(20A01603) HYDROLOGY AND IRRIGATION ENGINEERING

UNIT-IV

6. Provision of intercepting drains: These are generally constructed parallel to the canal. The water seeping from the unlined canal can be intercepted by providing intercepting. They give exceptionally good results for the reach where the canal runs in high embankments.

7. Increasing outflow from the groundwater reservoir: If the well irrigation is adopted in the area, the water table goes down and the chances of waterlogging are considerably less. In fact, a judicious combination of the canal irrigation and the well irrigation in the same area is an ideal solution for the waterlogging problems.

8. Changing the crop pattern: In regions susceptible to waterlogging, the crop pattern should be changed so that the crop requiring heavy irrigation should be avoided and those requiring light irrigation is encouraged.

9. Prevention of seepage from reservoir: The seepage from small reservoirs can be reduced by lining the surface of the reservoirs. Also suitably designed filters should be provided so that seepage from the reservoirs is discharged into streams.

10. Changing the assessment method: If the water supplied to the cultivators is assessed on area basis; the cultivators have a tendency to use excess water which causes waterlogging. By adopting the volumetric assessment of water, the excess use of water is controlled and the chances of waterlogging are reduced.

11. Adopting better methods of application of water: By adopting efficient methods of application of water, such as Sprinkler irrigation and drip irrigation, waterlogging can be prevented.

12. Educating the cultivators to use water economically: The cultivators should be apprised of ill effects of waterlogging. They should be trained to use water economically and avoid wasteful use of water.

Drainage of Irrigated lands:

Need for drainage: During rain or irrigation, the fields become wet. The water infiltrates into the soil and is stored in its pores. When all the pores are filled with water, the soil is said to be saturated and no more water can be absorbed; when rain or irrigation continues, pools may form on the soil surface.

Part of the water present in the saturated upper soil layers flows downward into deeper layers and is replaced by water infiltrating from the surface pools. When there is no more water left on the soil surface, the downward flow continues for a while and air re-enters in the pores of the soil. This soil is not saturated anymore. However, saturation may have lasted too long for the plant health. Plant roots require air as well as water and most plants cannot withstand saturated soil for long periods.

Besides damage to the crop, a very wet soil makes the use of machinery difficult, if not impossible. The water flowing from the saturated soil downward to deeper layers, feeds the groundwater reservoir. As a result, the groundwater level (often called groundwater table or simply water table) rises. Following heavy rainfall or continuous over-irrigation, the groundwater table may even reach and saturate part of the root zone (Fig. 1). Again, if this situation lasts too long, the plants may suffer. Measures to control the rise of the water table are thus necessary.

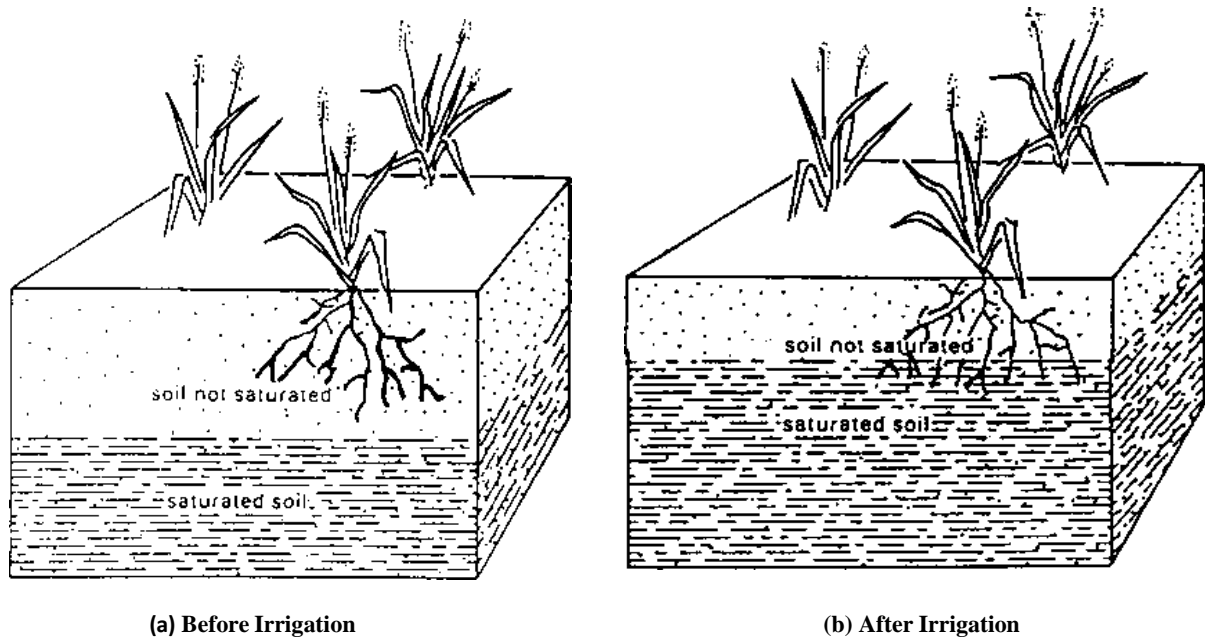

Fig: Groundwater table before and after irrigation

The removal of excess water either from the ground surface or from the root zone is called drainage. Excess water may be caused by rainfall or by using too much irrigation water, but may also have other origins such as canal seepage or floods. In very dry areas there is often accumulation of salts in the soil. Most crops do not grow well on salty soil. Salts can be washed out by percolating irrigation water through the root zone of the crops. To achieve sufficient percolation, farmers will apply more water to the field than the crops need. But the salty percolation water will cause the water table to rise. Drainage to control the water table, therefore, also serves to control the salinity of the soil.

Types of drainage:

Drainage can be either natural or artificial. Many areas have some natural drainage; this means that excess water flows from the farmers' fields to swamps or to lakes and rivers. Natural drainage, however, is often inadequate and artificial or man-made drainage is required. There are two types of artificial drainage:

(20A01603) HYDROLOGY AND IRRIGATION ENGINEERING
UNIT-IV

1. Surface drainage
2. Subsurface drainage

1. Surface drainage: Surface drainage is the removal of excess water from the surface of the land. This is normally accomplished by shallow ditches, also called open drains. The shallow ditches discharge into larger and deeper collector drains. In order to facilitate the flow of excess water towards the drains, the field is given an artificial slope by means of land grading (Fig. 2).

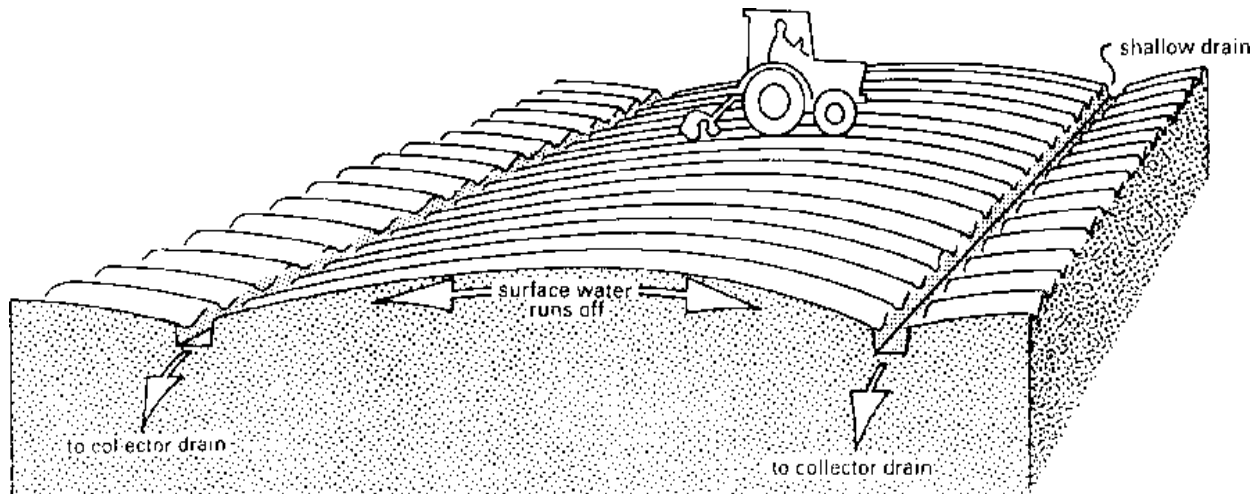

Fig: Surface drainage- The field is given artificial slope to facilitate drainage

2. Subsurface drainage: Subsurface drainage is the removal of water from the root zone. It is accomplished by deep open drains or buried pipe drains.

- i. Deep open drains

The excess water from the root zone flows into the open drains (Fig. 3). The disadvantage of this type of subsurface drainage is that it makes the use of machinery difficult. Open drains use land that otherwise could be used for crops. They restrict the use of machines. They also require a large number of bridges and culverts for road crossings and access to the fields. Open drains require frequent maintenance (weed control, repairs, etc.).

(20A01603) HYDROLOGY AND IRRIGATION ENGINEERING
UNIT-IV

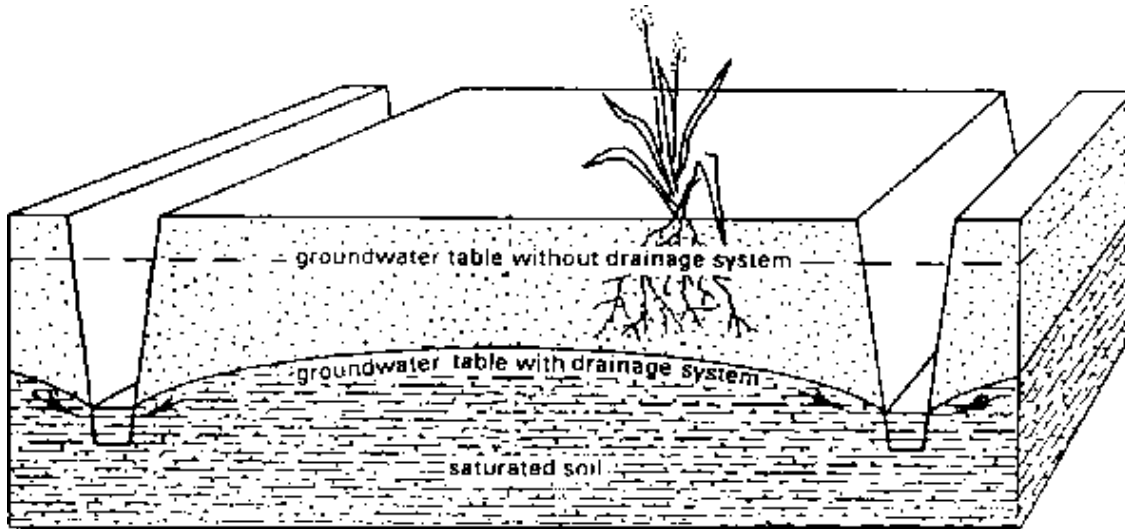

Fig: Deep open drains

ii. Pipe drains

Pipe drains are buried pipes with openings through which the soil water can enter. The pipes convey the water to a collector drain (Fig. 4).

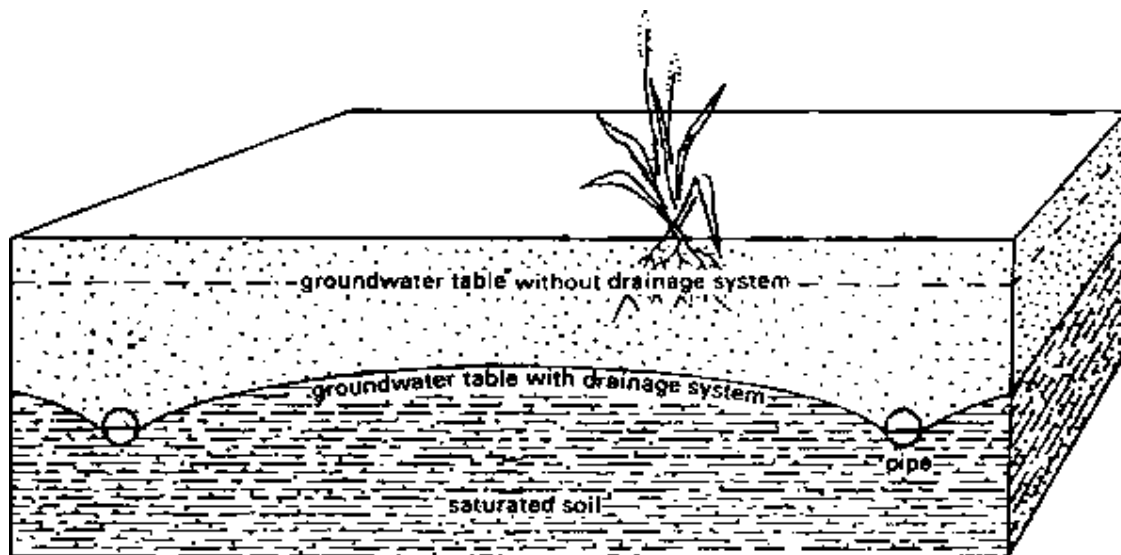

Fig: Pipe drains

Drain pipes are made of clay, concrete, or plastic. They are usually placed in trenches by machines. In clay and concrete pipes (usually 30 cm long and 5 -10 cm in diameter) drainage water enters the pipes through the joints. Flexible plastic drains are much longer (up to 200 m) and the water enters through perforations distributed over the entire length of the pipe. In contrast to open drains, buried pipes cause no loss of cultivable land and maintenance

(20A01603) HYDROLOGY AND IRRIGATION ENGINEERING
UNIT-IV

requirements are very limited. The installation costs, however, may be higher due to the materials, the equipment and the skilled manpower involved.

Saline and alkali soils:

Soils are classified as saline or alkaline mainly on the basis of their soluble salt concentration and exchangeable sodium content. Because both these parameters depend upon the moisture content of the soil, it is important to mention the moisture content used in the test. The most commonly used moisture content is the saturation moisture content as determined from a saturated, disturbed soil sample in the laboratory. The soil sample is brought to saturation condition by stirring it in distilled water. When the sample becomes fully saturated, the characteristic end point is reached. The soil glistens and flows slightly without free waterstanding on the surface. The solution is extracted from the soil in this condition for the test. The solution is called the saturation extract.

On the basis of the soluble salt concentration and exchangeable sodium content, the soils may be classified into 3 types:

1. Saline soils
2. Saline-alkali soils
3. Alkali soils

1. Saline soils: Saline soils are the soils which contain soluble salts in a large quantity such that the growth of the plants is hampered. A normal (non-saline) soil may become saline if the irrigation water contains large quantities of salts. The soil may also become saline by upward movement of ground water due to capillary action when the water table is high. In both these cases, the salts accumulate on the soil surface. The soluble salts in the saline soils are mainly chlorides and sulphates of calcium, magnesium and potassium. Sometimes nitrates of these elements are also found. The saline soils may also contain insoluble salts such as calcium sulphates (gypsum), calcium carbonates and magnesium carbonates. If the saturation extract contains less than 3 gm/l of salt, the soil is said to be non-saline, and if the salt concentration of the saturation extract contains more than 12 gm/l, the soil is said to be highly saline. The electrical conductivity of saline soils is greater than 4000 micromhos per cm at 25°C.

The saline soils can be reclaimed by reducing the soluble salt concentration to acceptable limits by leaching, provided adequate drainage occurs. For that purpose, more water is applied to the field than is required for crop growth. This additional water infiltrates into the soil and percolates through the root zone. During percolation, it washes the salts out of the root zone and takes these along to deeper layers. This is known as leaching.

2. Saline-alkali soils: The saline-alkali soils have characteristics somewhat in-between those of the saline and alkali soils. For such soils the electrical conductivity is greater than 4000

(20A01603) HYDROLOGY AND IRRIGATION ENGINEERING
UNIT-IV

micromhos per cm at 25°C, the exchangeable sodium percentage is greater than 15 and the pH value is about 8.5. Saline-alkali soils can be reclaimed by leaching, but before leaching, it is necessary to replace the exchangeable sodium ions present in the soil by calcium or other suitable ions. If this is not carried out the exchangeable sodium ions will be left after leaching which may deteriorate the soil structure due to dispersion of soil particles. It will result in a decrease in the permeability of the soil.

3. Alkali soils: Alkali soils have electrical conductivity less than 4000 micromhos per cm at 25°C, the exchangeable sodium percentage greater than 15 and the pH value between 8.5 and 10.0. These soils are also called black alkali soils because a black crust is formed on the surface of the soil if organic matter is present. It is very difficult to reclaim alkali soils. Such soils are quite impermeable. It becomes difficult for the water used for leaching to enter the soil and if once entered, it is more difficult to get it out. To replace the sodium ions, chemicals such as gypsum and sulphur are introduced in the soil to increase the concentration of soluble calcium so that it can replace exchangeable sodium. These chemicals are mixed with the soil mechanically. These can also be washed in if intake rate and permeability can be improved.

The permeability of the alkali soil can be improved temporarily by cultivation. The permeability can be improved somewhat permanently by converting the alkali soil to the saline-alkali soil. This is achieved by irrigating the land with saline water. As the soluble salt content is increased, the soil structure is improved and the permeability is increased. After the soil becomes fairly permeable, chemicals such as gypsum can be introduced to replace the sodium. After the exchangeable sodium percentage is decreased, the soil can be reclaimed by controlled leaching and drainage.

(20A01603) HYDROLOGY AND IRRIGATION ENGINEERING
UNIT-V

DIVERSION HEADWORKS:

Selection of site and layout, parts of diversion head-works, types of weirs and barrages, design of weirs on permeable foundations, control of silt entry into canal, silt excluders and different types of silt ejectors.

Definition

A structure constructed at the junction of the source (river, dam, canal) and the off taking canal.

Types of Headworks

The different types of headworks are as follows:

Diversion Headworks

- diverts the required supply from the source channel to the off taking channel
- water level in the source channel raised to the reqd. level
- reduces the need of excavation in the head reach
- command area is served better by flow irrigation
- should be capable of regulating the supplies into the off taking channel; all supplies when demand is keen & supplies are less
- control sediment entry

Storage Headworks

- fulfill requirements of the diversion headworks
- in addition, store excess water when available and release when demand exceeds supplies

Temporary Headworks

- bunds constructed across the river every year after floods
- replaced with permanent headworks when demand of water increases

Permanent Headworks - all important headworks

Location of Headworks on Rivers

Rivers have four stages: (i) rocky, (ii) boulder, (iii) trough (or alluvial), and (iv) delta

Rocky stage: far away from command area; length and, therefore, cost of main canal increases, so is unsuitable for headworks

Delta Stage: irrigation demand is less and, also, nature of river (flat slopes, braiding) poses other problems, hence unsuitable

Boulder and alluvial stages - both suitable

(20A01603) HYDROLOGY AND IRRIGATION ENGINEERING
UNIT-V

The favorable features of boulder stage for headworks are:

- initial cost is less
- local availability of stones
- smaller width of river (therefore, weir)
- smaller scour depths (reduce the depth of cut-off)
- close proximity of higher banks (less training works)
- canal will have number of falls – can be utilized for power generation
- construction of temporary bunds (for initial period) possible
- will require large number of cross-drainage structures
- considerable loss of water through subsoil flow in the river bed and from the head reach of the main canal - crucial during periods of short supply

Hilly regions usually have wet climate and, therefore, irrigation demand is, generally, small to begin with and may increase later. In alluvial regions the demand for irrigation is high right from the beginning.

Site Selection for Headworks

River reach should be:

- straight and narrow
- well-defined and non-erodible high banks
- preferably deep channels on both banks and shallow channel at the centre

Based on considerations of suitability of site for different components of headworks following points are important:

- weir (barrage) - minimum length for economy, uniform flow for proper functioning
- under sluices - presence of deep channel to ensure adequate supply to the off-taking canal
- canal alignment - capable of serving its command area without much excavation
- sediment – off taking channel sited on the downstream end of the outer side of the bend

Diversion Headwork Components

- Weir (or barrage)
- Under sluices
- Divide Wall
- Fish Ladder
- Canal Head Regulator
- Sediment Excluder and Sediment Ejector
- River Training Works

Layout of Headworks

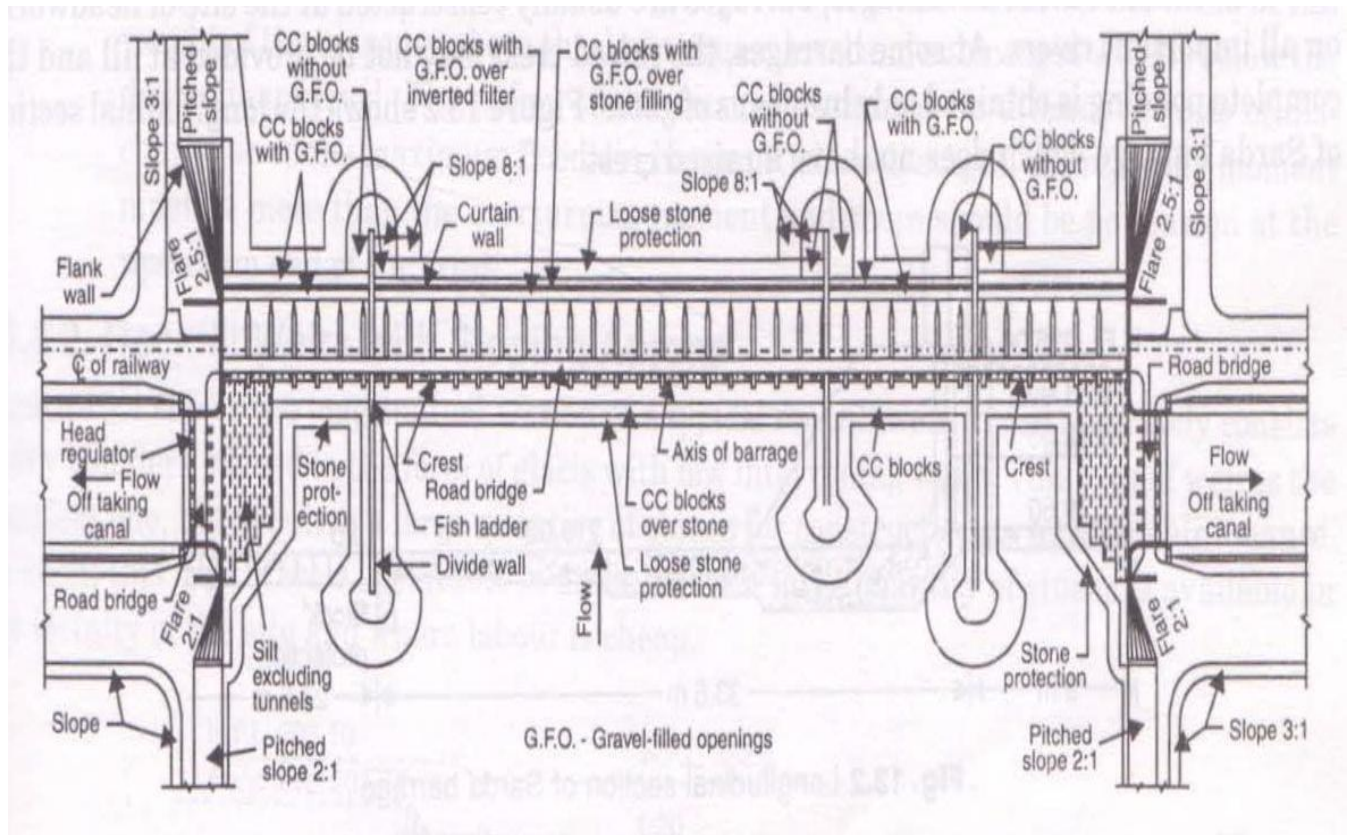

Fig : Typical layout of headworks

Weir (or Barrage)

Weir

- un gated barrier across a river
- raises water level in the river and diverts water into an off taking canal - on one or both banks of the river - just u/s of the weir
- usually aligned at right angle to the direction of flow - results in minimum length & normal uniform flow through all weir bays which minimizes the chances of shoal formation and oblique flow
- crest is raised above the river bed to raise the water level
- shutters at the top of the crest for further raising of water level and controlling pond level (difficult when pond level is higher than 2 m above the crest)
- provide gate-controlled weir - barrage

(20A01603) HYDROLOGY AND IRRIGATION ENGINEERING
UNIT-V

Barrage

- a gate-controlled weir with its crest at a lower level
- ponding up of the river for diversion is by means of gates
- offer better control on outflow and discharge in the offtaking canal
- afflux is small due to lower crest level of the barrage
- possible to provide a roadway across the river at small cost
- better control over sediment entry into canal
- Therefore, barrages are very common on all important headworks at times no raised crest as in Sarda barrage - ponding is by gates only design procedure is similar to that of weir

Types of Weirs

Masonry weirs with vertical d/s face

- masonry floor with a masonry crest on top of which shutters for ponding
- shutters dropped during floods to reduce afflux
- stability of crest examined for water level up to the top of shutter with no flow d/s when shutters dropped and water is on both sides of the crest

Rockfill weirs with sloping aprons

- simplest but requires large qty. of stones for constn. & maintenance

Concrete weirs (or barrages) with glacis

- on pervious foundation, only concrete weirs these days
- excess energy dissipated by means of hyd. Jump formed on glacis
- design based on Khosla's method and requires the knowledge of
- max. flood discharge & corresponding level around the weir site
- the stage - disch. Curve at the weir site
- the X-section of the river at the site

Based on the site conditions, general & economic considerations, decide

- afflux
- pond level
- min. waterway
- weir crest level

under sluices (Sluice Ways or Scouring Sluices)

- under sluices help in flushing the sediment deposited u/s of the canal head regulator on account of ponding up of water due to construction of weir across river
- gate-controlled openings in continuation of the weir with their crests at lower level
- located on the same side as the off taking canal

(20A01603) HYDROLOGY AND IRRIGATION ENGINEERING
UNIT-V

- useful for passing low floods after meeting the requirements of the offtaking canal
- shutters (or gates) operated only for passing high floods during monsoon
- design procedure is similar to that of weir (use model analysis for major headworks)

Crest level of under sluice:

- generally, coincides with the lowest cold weather level of the river bed at the weir site
- at least 1.2 m (2 m if sediment Excluder is provided) below that of the head regulator so that the sediment deposited u/s of the regulator does not enter the off taking canal. If needed, the crest level of the regulator is raised.

Discharge capacity of the under sluices is maximum of the following:

- twice the canal discharge - to ensure sufficient scouring capacity
- 10 - 20 % of the max. flood discharge - to reduce the length of the weir
- enough capacity to pass off low floods with w/s in the reservoir at pond level to avoid gate operation

Afflux & Waterway

- HFL u/s of weir rises due to construction of weir across river, this rise is afflux
Afflux = u/s TEL - d/s TEL
- initially, the afflux is confined to a short reach u/s of weir but, gradually extends very far u/s in case of alluvial rivers - due to continued deposition
- afflux governs top levels of guide banks & marginal bunds & length of bunds
- waterway & afflux are interdependent
 - larger afflux results in lesser waterway
 - increases the discharge intensity q which, in turn,
 - increases the scour &, hence, cost of protection works d/s
 - higher afflux also increases the risk of failure of river training works
- For alluvial rivers:
 - afflux = 1m in upper and middle reaches of river
 - = 0.3m in lower reaches with flat gradients
 - waterway = 1.1 to 1.2 times Lacey's regime perimeter for the design discharge
 - = 0.8 to 0.9 times regime perimeter in rivers with coarser bed material
- lesser waterway increases afflux & cost of protection & river training works
- larger waterway is uneconomical & causes oblique flow and silting in part of waterways

Looseness factor:

- overall length of weir /min. stable width from regime criterion

Pond level:

- water level which must be maintained in the under-sluice pocket (i.e. u/s of the canal head regulator) so as to maintain FSL in the canal when full supply discharge is fed into it

(20A01603) HYDROLOGY AND IRRIGATION ENGINEERING

UNIT-V

- = FSL + (1.0 to 1.2 m) so that sufficient working head is available even when head reach of canal has silted up or when canal is to be fed excess water
- limit on pond level : FSL = pond level - working head (1.0 to 1.2 m)
- maintained by keeping the weir crest at the pond level or by keeping the weir crest at lower level and provide shutters/gates

Retrogression:

- d/s of weir due to degradation; d/s HFL lowered; exit gradient increases during high floods : 0.3 to 0.5 m due to large qty. of sediment; during low floods : 1.25 to 2.25m due to relatively clear water for design flood retrogression is assumed 0.3 to 0.5 m

d/s TEL = u/s TEL - head loss (= afflux + retrogression)

Divide Wall

- parallel to canal head regulator
- separates main weir bays (and floor) from under sluice bays (and floor)
- extends on both sides of weir up to the end of the floor or loose apron
- on d/s it avoids cross flow causing scour near the structure
- isolates canal head regulator from main river flow
 - creates still pond in front of the regulator
 - helps in deposition of sediment and relatively clear water in canal
 - improves scouring of under sluices by ensuring straight approach
- additional divide walls if possibility of cross currents exist
- generally, of strong masonry with top width of about 1.5 to 2.25m and nose end sloping at 3(V):1(H); slight divergence of 1 in 10 advisable; extending up to about the u/s end of the canal or half to 2/3rd the length of the regulator

Fish ladder

- fish of various kinds
- migrate to d/s in the beginning of winter in search of warmth
- return u/s before the monsoon for clear water
- a narrow opening (Fish ladder) between the divide wall and the under sluices where water is always present
- baffles to reduce the velocity to less than 3.0 m/s
- these openings are called as fish ladder or fishways or fish pass
- should take into account the requirements of the fish of the river

(20A01603) HYDROLOGY AND IRRIGATION ENGINEERING
UNIT-V

DESIGN OF WEIR

Data required:

1. L-section & x-section of river at the weir site
2. stage - Q relationship
3. sediment characteristics
4. data concerning the off taking canal (FSL, Q, L- & X-sections)

Determination of weir crest level

1. Determine HFL for the design flood (50 to 100 yr. Frequency) from stage-Q curve.
2. d/s TEL = HFL + regime velocity head
3. u/s TEL = d/s TEL + permissible afflux + retrogression, if any
4. q = design flood discharge / width of clear waterway
5. determine k (height of TEL over the weir crest) from

$$q = Ck^{3/2}$$

C is based on model studies, otherwise

= 1.71 for broad-crested weir

= 1.84 for small-crested weir

6. weir crest level = u/s TEL - k

Length & number of weir bays & height of shutters/gates:

Calculate total discharge capacity of weir and under sluices taking into account the end contractions

$$Q = C(L - KnH)H^{3/2}$$

K = f(pier shape) may vary from 0.01 to 0.1

L = overall waterway length

n = number of end contractions

H = total head over the weir

Height of shutters/gates = pond level - weir crest level (max. value = 2m for falling shutters)

Vertical cutoffs

(20A01603) HYDROLOGY AND IRRIGATION ENGINEERING

UNIT-V

- Vertical cutoffs at both u/s & d/s ends of the weir and also at intermediate location (ends of slopes) guards against scouring at u/s & d/s and piping at d/s
- Intermediate cutoffs hold the main structure in case of failure of u/s & d/s cutoffs bottom of cutoff is lower than the level of possible scour
- d/s cutoff should also reduce exit gradient to safe value the depth of scour below HFL

$$R = 1.35 \left(\frac{q}{f} \right)^{1/3}$$

q calculated taking into account the concentration factor by which q is to be multiplied to take into account the non-uniformity of flow along the waterway during the operation of weir bays

The scour depth R (for regime conditions) increased further as follows:

u/s of impervious floor	1.50 R
d/s of impervious floor	2.00 R
Nose of guide banks/divide wall	2.25 R
Transition from nose to straight part	1.50 R
Straight reaches of guide banks	1.25 R

Weir crest, glacis, and impervious floor:

- Weir crest at the computed level with a width of about 2m
- For broad-crested weir, width should be greater than 2.5 times H
- u/s slope of weir : 2(H):1(V) to 3(H):1(V)
- d/s slope and horizontal floor (i.e. stilling basin) should cause max. dissipation of energy through hydraulic jump and also be economic
- Slope of d/s glacis : 3(H):1(V)
- Level of the d/s floor so that jump starts at the end of the glacis (or u/s) for all Q's
- Location of the jump is calculated for HFL and pond level discharges
- Level of floor is at lower of the required levels for these two conditions
- length of floor such that the entire jump is on the floor (5 to 6 (h - h))
- u/s floor at the river bed level and its length so that the resulting exit gradient at the d/s end is less than the safe value for the soil under consideration (1/5 to 1/6 for coarse and 1/6 to 1/7 for fine sand, 1/4 to 1/5 for shingles)
- Thickness of the floor from uplift considerations

Upstream and downstream loose protection

- in the form of concrete blocks and loose stones for protection against scour
- u/s: concrete blocks of size 1500x1500x900 mm laid over loose stones for a distance equal to depth of scour below the floor level
- d/s: concrete blocks on inverted filter; space between blocks filled with gravel; length is 1.5 times the scour depth below the floor level.
- for the boulder reach the size of blocks will be increased
- Inverted filter in two or more layers
- toe wall of masonry/concrete at the end of the filter to a depth of about 500mm
- launching aprons beyond block protection on u/s & d/s ; stones larger than 300mm

Canal Head Regulator

- regulates the discharge into the canal
- controls the entry of sediment into the canal
- usually aligned at an angle of 90 - 110 degrees to the barrage axis minimizes entry of sediment into the canal, prevents backflow and stagnation zones in the under sluice pocket
- discharge controlled by steel gates of 6 - 8 m spans usually; larger spans also used - electric winches required for operation
- pond level = FSL + 1.0 to 1.2 m of working head
- waterway width - so that the canal can be fed its full supply with 50% of working head if more than the canal width, provide a converging transition d/s of regulator
- The required head over the crest H for passing a discharge Q with an overall waterway L is worked out using

$$Q = C(L - KnH)H^{3/2}$$

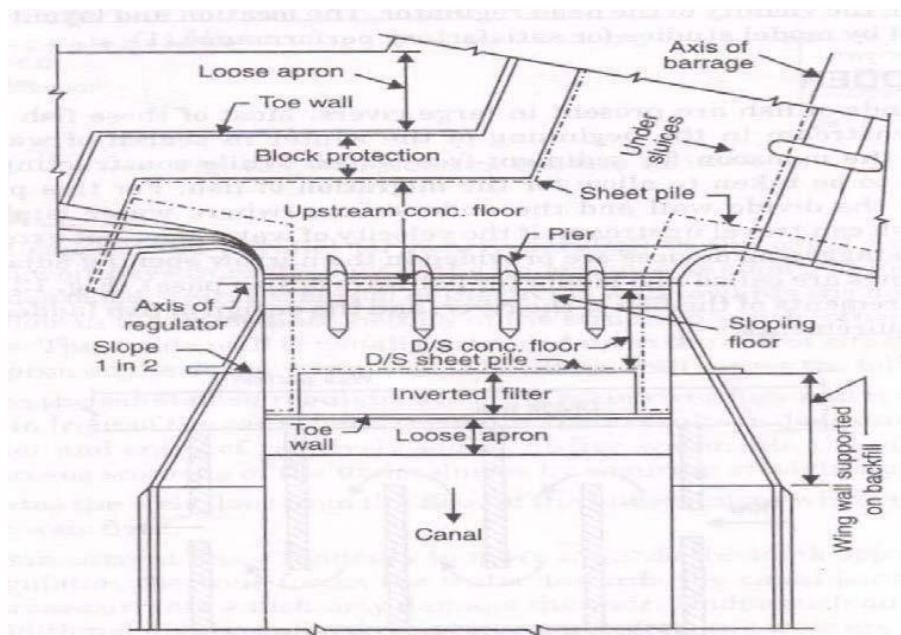

. Fig: Typical Plan of a Head Regulator

(20A01603) HYDROLOGY AND IRRIGATION ENGINEERING
UNIT-V

- crest level = pond level - head over the crest required to pass the full supply Q kept higher than the cill of the under sluices to prevent sediment, entry should also take into account sediment excluder, working head waterway width
- Height of gates = pond level - crest level
- RCC breast wall between HFL and pond level

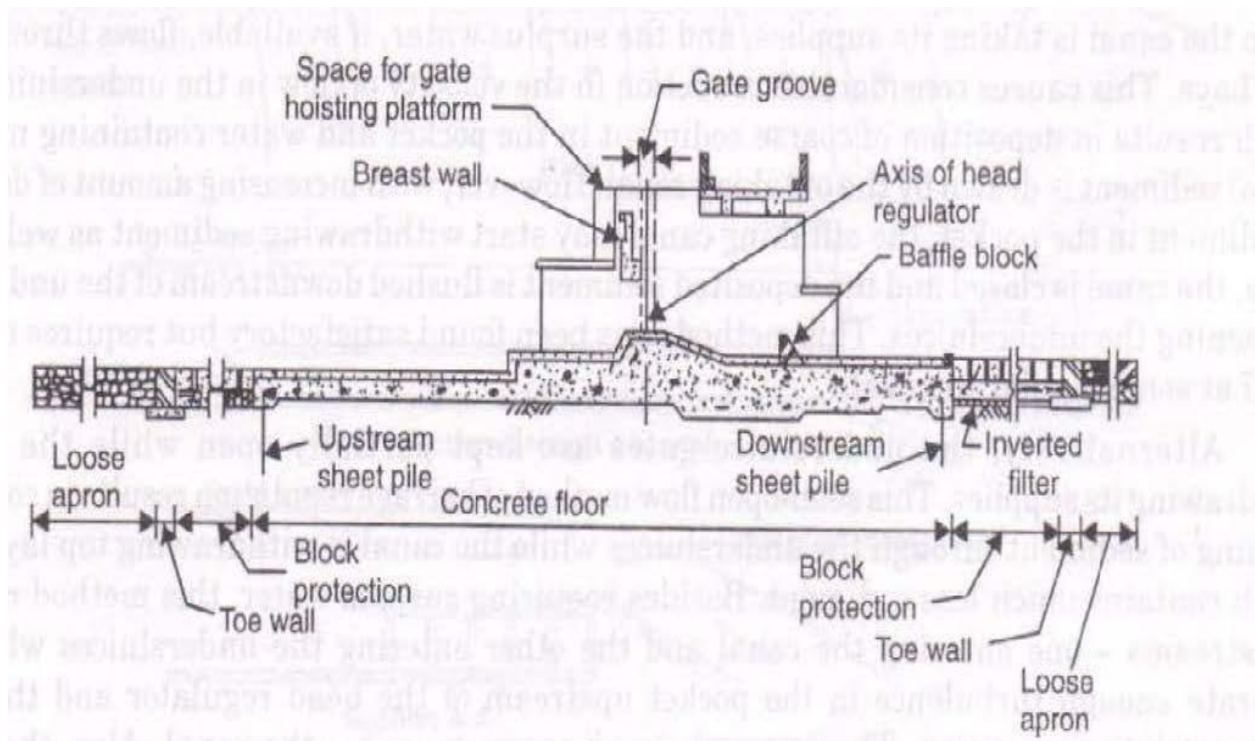

Fig: Typical Section of a Head Regulator

- Canal head regulator is designed as weir
- Canal kept closed during highest flood passing through the river, this is the worst static condition and the floor should resist this uplift
- jump through region - worst condition may occur when some discharge passes safety of this part checked for different discharges including the maximum one
- a bridge and a working platform (for operation of gates) across the regulator

(20A01603) HYDROLOGY AND IRRIGATION ENGINEERING
UNIT-V

Sediment control in canals

Excess sediment entering the canal reduces its capacity, therefore, adequate preventive or curative measures for sediment control entry of sediment can be partly controlled by barrage regulation methods.

1. Still pond method:

- under sluices kept closed when canal takes its supplies
- excess water flows through weir bays
- causes still pond condition
- sediment deposited at the bed; canal draws clear water
- when considerable sediment deposited, canal is closed and sediment is flushed d/s of the under sluices though satisfactory, requires frequent closing of the canal

2. Semi-open flow method:

- under sluices gates are kept partially open while canal is taking its supplies
- results in continuous flushing of sediment
- requires surplus water
- the two streams - to river & to canal generates turbulence, bring sediment into suspension, and may enter canal; not suitable except during floods when water is surplus

3. Wedge-flow method:

- under sluices near the divide wall are opened more
- the under sluices near the regulator are opened less
- results in wedge-like flow resulting in favorable flow curvature in the under-sluice pocket and, thus, reduces sediment entry into canal

Some important points:

- When the stream carries high sediment load, close the canal itself
- Barrage regulation methods have their limitations requiring either closure of canal or surplus water. Therefore, sediment excluder/ejector and stilling basins are constructed.
- Sediment excluders/ejectors take advantage of the fact that the bed load part of the transported sediment in a stream moves near bed and the suspended load part is distributed non-uniformly in the vertical with heavier concentrations near the bed.
- Settling basins reduce the sediment transport capacity of the canal flow by enlarging the flow cross-section over the length of the basin. The deposited sediment is suitably removed.

Sediment excluder (or silt excluder)

- most commonly used preventive measure
- constructed in river bed in front of the canal regulator
- flow u/s of regulator divided by a platform below which excluder tunnel
- only upper layer water enters the canal; carries much less sediment

(20A01603) HYDROLOGY AND IRRIGATION ENGINEERING
UNIT-V

- lower layer water passes d/s of weir/barrage through the excluder tunnels
 - tunnels are parallel to the axis of the regulator and are of different lengths
 - all tunnels terminate at the end of the under sluice bays
 - tunnels accommodated in the space between regulator crest and under sluice floor
 - design procedure based on thumb rules evolved from past experiences
1. min. discharge through excluder tunnels: about 20% of canal discharge
 2. self-flushing velocity in tunnels depend on sediment size: 1.8 to 4.0 m/s
 3. usually, 2 to 6 tunnels: usually rectangular x-section and bell-mouthed
 4. tunnels accommodated in the space between regulator crest floor and under sluice floor - determines height of the tunnels keeping in mind the self-flushing velocity and convenience for inspection & repair
 5. estimate the waterway width required for tunnels
 6. divide the width into a suitable number (whole number for one sluice bay) of one sluice bay) of tunnels
 7. length of the tunnel nearest the regulator equals the length of the regulator
 8. other tunnels are successively shorter - mouth of longer is in the suction zone of the shorter one - so that no dead zone between adjacent tunnels
 9. water and sediment discharge of all the tunnels should be the same this requires width of shorter tunnel to be smaller to satisfy resistance condition
 10. designed excluder is model-tested

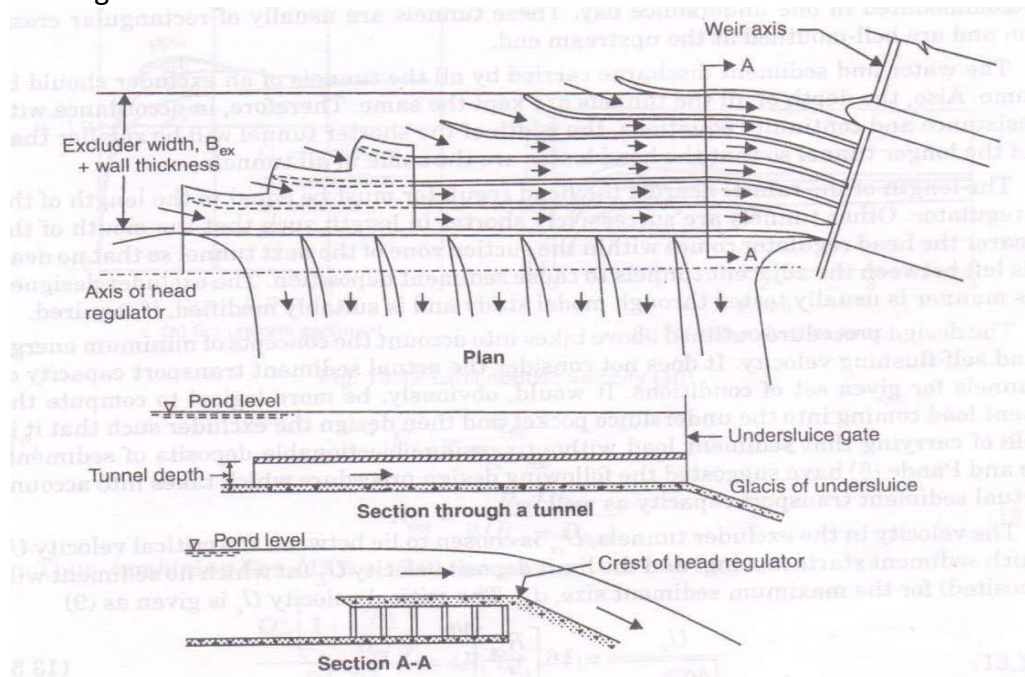

Fig: Typical Layout a Sediment Excluder

(20A01603) HYDROLOGY AND IRRIGATION ENGINEERING
UNIT-V

Above design procedure is based on self-flushing concept and does not take into account the sediment transport capacity of the tunnels. Garde and Pande have suggested an alternative method for this purpose.

Sediment Ejector /Extractor (Or Silt Ejector/Extractor)

- curative measure; removes excess sediment load that has entered the canal
- constructed in canal d/s of the canal head regulator
- taking advantage of the concentration distribution, the near-bed water layers ejected
- not too near the regulator - residual turbulence keeps the sediment in suspension
- not too far from regulator - sediment deposits d/s of regulator and reduces canal capacity reach up to the ejector to be wide to carry extra discharge for ejector
- ejector spans the entire width of the canal ; divided into tunnels which, in turn, are subdivided with gradually converging turning vanes to accelerate the escaping flow
- main components - diaphragm, tunnels, control structure and an outfall channel
- diaphragm so shaped as to cause least disturbance to sediment concentration u/s of it
- diaphragm level = f(sediment size to be ejected, size of tunnels and u/s & d/s canal levels)
- lower side of u/s end of diaphragm is bell-mouthed/or made elliptical
- escaping discharge - generally 10 to 20 per cent of full supply discharge
- tunnel dimensions - resulting velocity is adequate to carry the sediment of desired size about 20-25% depth of flow in the canal
- tunnels further converged to increase the velocity further by 10-15%; range 2.5 - 6m/s
- depth of tunnels; 1.8 - 2.2 m to facilitate inspection and repair
- ejector discharge is controlled by regulator gates(near the outfall)
- outflow led to natural drainage through outfall channel design to have self-cleansing velocity
- sufficient drop between FSL of the outfall channel and HFL of the drainage
- proposed design model-tested

The efficiency E of the sediment ejector (or excluder) is given as:

$$= \left[\frac{IU - ID}{IU} \right] 100\%$$

IU and ID are sediment concentration in the canal u/s and d/s of the ejector.

Settling Basin:

- removal of sediment from flowing canal by reducing flow velocity through a long expansion
- reduces velocity, shear, turbulence which stops sediment movement and also deposition of suspended sediment
- material from the bed of the basin suitably removed and disposed of

(20A01603) HYDROLOGY AND IRRIGATION ENGINEERING
UNIT-V

Design of settling basin:

- size of sediment particle = d
- fall velocity of the particle = w
- depth of flow in the basin = D
- velocity of flow in the basin = U
- Time required by a particle on the w/s to reach the bed of the basin = D/w
- Horizontal distance travelled by the particle during this time = UD/w (i.e length of basin, L)
- Fall velocity is affected by turbulence, concentration etc.
- Therefore, length of basin $L = UD/w$ is increased by about 20%.

Garde, Ranga Raju and Sujudi method for design of settling basin:

- Efficiency of removal of sediment (n) by settling basin:

$$n = \frac{q_{si} - q_{se}}{q_{si}}$$

q_{si} & q_{se} are amounts of sediment of a given size entering and leaving the basin

- Based on dimensional analysis and experimental investigation, they obtained

$$n = n_o (1 - e^{-\frac{KL}{D}})$$

n_o & K are related to w/u^* (u^* is the shear velocity).

River training works for canal headworks

Purposes:

- to prevent outflanking of the structure
- to minimize cross flow (through weir) which may endanger the structure
- to prevent flooding of the riverine land's u/s of the weir
- to provide favorable curvature of flow u/s of the head regulator

Types (usually provided):

- Guide banks to narrow down & restrict the course of the river so that it flows centrally
- Approach embankments aligned with the weir axis and extend up to a point beyond the range of the anticipated meander loop
- Afflux embankments - earthen embankments extending from both approach embankments connected to the u/s ground above the affluxes highest flood level
- Spurs Launching apron, Stone pitching etc.